



Traffic & Transportation Direction

Planning Proposal - Industrial Rezoning

361 Oxley Highway, Gilgandra

Traffic Impact Assessment

April 2024

Reference: 814 rep 240416 final

Planning Proposal - Industrial Rezoning

361 Oxley Highway, Gilgandra

Traffic Impact Assessment

Prepared for: Gilgandra Shire Council

Status: Final report

Date: 16 April 2024

Reference: 814 rep 240416 final

Contact

Website: www.amberorg.com.au

E: info@amberorg.com.au

Phone: 1800 022 363

Table of Contents

1.	Introduction	1
2.	Transport Environment	4
2.1	Site Location.....	4
2.2	Road Network	6
2.3	Traffic Conditions	7
2.4	Sustainable Transport	10
2.5	Crash History.....	10
3.	Planning Proposal	11
4.	Traffic Assessment	13
4.1	Traffic Generation.....	13
4.2	Trip Distribution	14
4.3	Cumulative Traffic Impacts.....	17
4.4	Traffic Assessment.....	17
4.5	Summary.....	24
5.	Access and Internal Road Layout	25
5.1	Road Alignment.....	25
5.2	Road Design.....	25
5.3	Intersection Design	25
5.4	Sight Distance.....	27
5.5	Lot Access	27
6.	Railway Level Crossing Impacts	29
7.	Car/Bicycle Parking and Loading Facilities.....	30
8.	Alternative Transport Modes.....	31
9.	Conclusion	32

Appendices

Appendix A

Oxley Highway – Survey Results

Appendix B

Intersection Turning Movement Surveys

Appendix C

SIDRA Results

Appendix D

Site Access Intersection Design

Appendix E

Swept Path Assessment – Site Access



1. Introduction

Amber Organisation has been engaged by Gilgandra Shire Council to advise on the traffic and parking matters associated with the Planning Proposal to rezone land at 361 Oxley Highway in Gilgandra (Lot 1 and part of Lot 2 in DP 1070081) for industrial use.

The site is approximately 52 hectares in size and is proposed to be rezoned from RU1 - Primary Production to E4 - General Industrial with a minimum lot size of 5,000sqm and no height limit or Floor Space Ratio (FSR). The northern-most 21-hectare section with frontage to the Oxley Highway is intended to be developed as a fully serviced industrial area. Gilgandra Shire Council has provided an indicative site layout for the subdivision of this section which includes construction of 27 industrial lots along with the associated internal road network. Access is expected to be provided via a new priority-controlled intersection with Oxley Highway.

An approved 12-hectare solar farm is to be located on the southern part of the site with access via Aralee Road however is yet to be constructed. This TIA report assumes that the balance of the site will not generate industrial related traffic until after the approved solar farm has reached the end of its productive life and is removed, which is estimated to occur in 35 years.

This report has been prepared to provide a Traffic Impact Assessment supporting the Planning Proposal to provide Council, regulatory agencies and the Department of Planning, Housing and Infrastructure confidence that the proposal can be delivered with acceptable impacts to the local traffic environment. It is based on surveys and observations at the site and our experience of similar developments elsewhere.

2. Response to TfNSW Comments

The Traffic Impact Assessment has been prepared in response to comments provided by TfNSW as outlined within Table 1.

Table 1: Response to TfNSW Comments

TfNSW Comment	Response
<p>Traffic volumes including:</p> <ul style="list-style-type: none"> Existing background traffic, Project-related traffic for each phase or stage of release of land associated with the proposals (for both industrial/employment lands and residential lands), Projected cumulative traffic at commencement of operation, and a 20-year horizon post-commencement (for both industrial / employment lands and residential lands). 	<p>An overview of the existing background traffic is provided within Section 3.3.</p> <p>The project-related traffic volumes are assessed within Section 5 which includes application of an estimated 1.5% compounding annual growth rate for background traffic over 20 years.</p>
<p>Traffic characteristics of both industrial/employment and residential zoning proposals including:</p> <ul style="list-style-type: none"> Number and ratio of heavy vehicles to light vehicles, Peak times for existing traffic (including consideration for harvest season), Origin / destination for vehicles to clarify distribution at each intersection. 	<p>The traffic characteristics of the proposed industrial rezoning are considered in Section 5 including light and heavy vehicles, peak travel times and expected vehicle distributions across the road network.</p> <p>It is noted that the proposal does not include any residential rezoning.</p>
<p>Traffic modelling (SIDRA) analysis for each affected intersection.</p>	<p>SIDRA intersection modelling has been carried out at 5 locations as outlined in Section 5.4.</p>
<p>Explore the potential for suitable alternative local road routes (including Aralee Road), particularly for commuter traffic to the industrial employment precinct.</p>	<p>The results of this assessment indicate that access for the industrial subdivision is able to be suitably accommodated via Oxley Highway with no notable impacts to traffic safety or efficiency.</p>
<p>Consider the development impact on existing freight network and any resulting change in traffic movement in and around the inland rail network.</p>	<p>The Inland Rail project is located to the north and west of Gilgandra. It is expected that the majority of Project traffic will travel to/from the south and east as outlined in Section 5.2 and will therefore have no notable impact on the Inland Rail network.</p> <p>An assessment of the project impacts on the railway level crossing located approximately 2 kilometres east of the site on Oxley Highway is provided within Section 7.</p>

TfNSW Comment	Response
<p>Based on the conclusions from the TIA, the proposal should identify necessary road network infrastructure upgrades that are required to cater for and mitigate the impact of the proposals. (for instance, new intersection treatments including turn lanes). In this regard, preliminary concept drawings of road upgrades / intersections should be drafted for TfNSW consideration. Such preliminary concept drawings should include:</p> <ul style="list-style-type: none"> • A design consistent with Austroads Guides, Australian Standards and TfNSW supplements, • A swept path analysis for the design vehicle (notably a PBS 3 (53m length)) and check vehicle (e.g. a 'special agricultural vehicle' typically used during harvest season), • Safe Intersection Sight Distance in accordance with Austroads Guides. 	<p>Assessment of the required turn treatments at the site access on Oxley Highway is provided in Section 6.3.1.</p> <p>A concept design has been prepared based on the relevant guidelines and is provided in Appendix D. The design vehicle and check vehicle have been determined based on advice from Gilgandra Shire Council as follows:</p> <ul style="list-style-type: none"> • Design vehicle – 26.0m B-Double • Check Vehicle – 35.4m B-Triple <p>Swept paths are provided for each vehicle in Appendix E.</p> <p>A sight distance assessment has been undertaken within Section 6.4.</p>
<p>The preliminary concept drawings will also assist with identifying the total footprint of the intersection required, impact to property boundaries and utilities/services. The plan will provide Council with details to estimate costs of delivering the intersections for inclusion in a contribution plan (e.g. s.7.11 Development Contributions Plan) or other funding mechanism.</p>	<p>The concept drawing provided in Appendix D outlines the total footprint of the site access intersection.</p>

3. Transport Environment

3.1 Site Location

The site is located on the southern side of Oxley Highway in Gilgandra, approximately 3.2 km west of Castlereagh Highway. Figure 1 shows the location of the site in relation to the surrounding road network.

Figure 1: Site Location



Source: OpenStreetMap

The site and the surrounding area to the south, west and northwest are predominantly zoned RU1 – Primary Production and occupied by open grassed fields. Land to the east and north is zoned R1 - General Residential and further north is zoned SP2 – Infrastructure associated with the Gilgandra Airstrip. Other notable land use in the area includes Gilgandra Shire Depot which is located opposite the site on the northern side of Oxley Highway.

The site is currently undeveloped with open grassed fields and scattered trees. Access to the road network is provided via a dirt track connecting with Oxley Highway near the northwestern corner of the site. Aralee Road runs along the eastern boundary of the site and connects with Oxley Highway however does not provide vehicular access to the site.

The site has a frontage to Oxley Highway of approximately 635 metres and a total area of approximately 52 hectares.

Figure 2 shows an aerial photograph view of the site and the surrounding area. The figure shows that the site and surrounding area is predominantly agricultural land, with the Gilgandra Shire Depot on the northern side of Oxley Highway.

Figure 2: Aerial Photograph



Source: SIX Maps

3.2 Road Network

A summary of the surrounding road network is provided within Table 2.

Table 2: Road Network

Road	Class	Typical Width	Speed Limit	Alignment
Oxley Highway	State Road	8.0m providing one lane of traffic in each direction and narrow sealed shoulders.	80 km/hr	General east-west alignment linking Port Macquarie and the Pacific Highway to the New England Highway near Bendemeer. Oxley Highway continues west of Tamworth, through Gunnedah and extends to link with the Newell Highway near Coonabarabran. Within the Gilgandra township it connects with Newell Highway and Castlereagh Highway. It terminates at its connection with the Mitchell Highway at Nevertire.
Newell Highway	State Road	8.0m providing one lane of traffic in each direction and narrow sealed shoulders.	60 km/hr	General northeast-southwest alignment between Goondiwindi in QLD and the NSW/VIC border.
Castlereagh Highway	State Road	8.0m providing one lane of traffic in each direction and narrow sealed shoulders.	80 km/hr	General north-south alignment between St George in QLD and Marrangaroo in NSW.
Hargraves Lane	Regional Road	8.0m providing two way vehicle movement.	60 km/hr	General north-south alignment between Oxley Highway and Newell Highway in Gilgandra. Heavy vehicle bypass route near Gilgandra.
Federation Street	Local Road	7.0m providing one lane of traffic in each direction.	50 km/hr	General north-south alignment between Castlereagh Highway and Oxley Highway in Gilgandra. Heavy vehicle bypass route near Gilgandra.

An overview of the key intersections within the surrounding area is provided in Table 3.

Table 3: Intersection Summary

Intersection	Configuration	Control / Turn Treatments
Oxley Highway / Federation Street	T-intersection	'Give Way' signage and associated line marking are provided for vehicles exiting Federation Street. No turn treatments are provided.
Oxley Highway / Hargraves Lane	T-intersection	'Give Way' signage and associated line marking are provided for vehicles exiting Hargraves Lane. No turn treatments are provided.
Castlereagh Highway / Federation Street	T-intersection	'Give Way' signage and associated line marking are provided for vehicles exiting Federation Street. No turn treatments are provided.
Newell Highway / Hargraves Lane	T-intersection	Priority controlled with vehicles exiting Hargraves Lane required to give way.

A railway level crossing is located approximately 2 kilometres east of the site on Oxley Highway adjacent to Gilgandra Station. The level crossing is provided with signals and warning signage however no boom gate is installed.

3.3 Traffic Conditions

3.3.1 Oxley Highway

In order to determine the road environment within the vicinity of the site, Gilgandra Shire Council has provided tube count survey data for Oxley Highway near the site frontage. The surveys were undertaken between Tuesday 28 November and Wednesday 6 December 2023.

The detailed survey results are provided within Appendix A with a summary in Table 4 below.

Table 4: Traffic Count Summary

Traffic Count Summary		Direction of Travel		
		Both Directions	Westbound	Eastbound
Traffic Volume (Vehicles/Day)	Weekday Average	679	342	337
	Weekend Average	544	271	274
Weekday AM/PM Peaks	9:00am – 10:00am	63	21	42
	5:00pm – 6:00pm	54	30	24
Classification %	Light Vehicles	-	81.5%	77.9%
Speed	Average Speed	76.7 km/hr	78.4 km/hr	75.1 km/hr
	85 th Percentile Speed	86.7 km/hr	87.9 km/hr	85.0 km/hr

Overall, the survey results indicate Oxley Highway accommodates a low to moderate level of traffic for its road classification and can accommodate an increase in traffic volumes.

3.3.2 Key Intersections

Turning movement count survey data has been provided by Transport for New South Wales (TfNSW) for the following key intersections which are highlighted within Figure 1:

- Oxley Highway / Federation Street
- Oxley Highway / Hargraves Lane
- Castlereagh Highway / Federation Street
- Newell Highway / Hargraves Lane

The surveys were undertaken on Tuesday 4 April and Wednesday 5 April 2023. Recorded traffic volumes at all intersections were higher during the Wednesday survey and accordingly this data has been utilised for the assessment.

A summary of the results is presented below with the full survey data provided within Appendix B. It is noted that the 'total' volumes include cyclists and therefore may not equal the sum of the light and heavy vehicle counts.

3.3.2.1 Oxley Highway / Federation Street

Figure 3: Oxley Highway / Federation Street - Turning Movement Count Peak Hour Survey Results

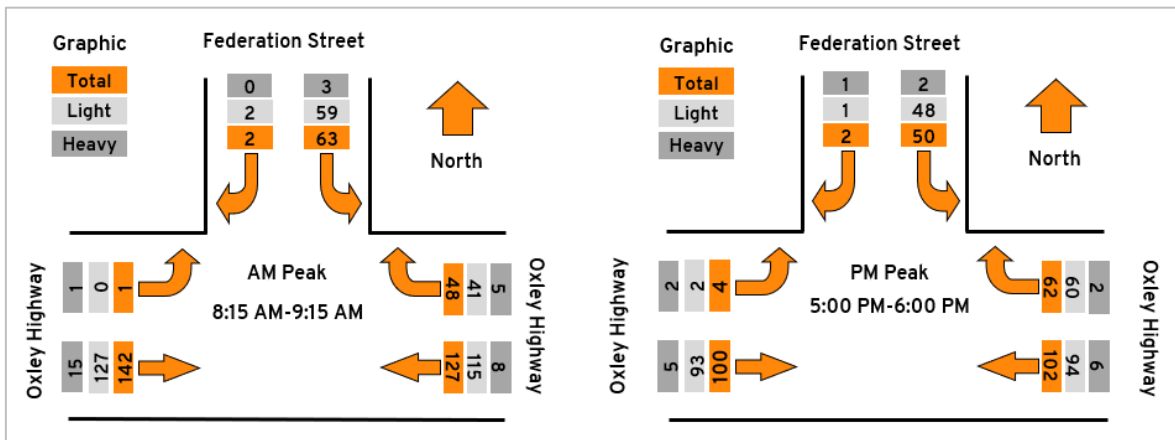

The survey results indicate the intersection currently carries a relatively low level of traffic in the order of 383 and 320 vehicles in the morning and evening peak hour, respectively. The morning peak hour was recorded from 8:15am to 9:15am and the evening peak hour was recorded from 5:00pm to 6:00pm.

The majority of vehicle trips during both peak hours are through movements on Oxley Highway. Vehicles entering or exiting Federation Street typically travelled to/from the eastern leg of Oxley Highway with very few turning movements recorded to/from the west. Overall, the results indicate both roads carry a relatively low level of traffic and can accommodate an increase in traffic.

3.3.2.2 Oxley Highway / Hargraves Lane

Figure 4: Oxley Highway / Hargraves Lane - Turning Movement Count Peak Hour Survey Results

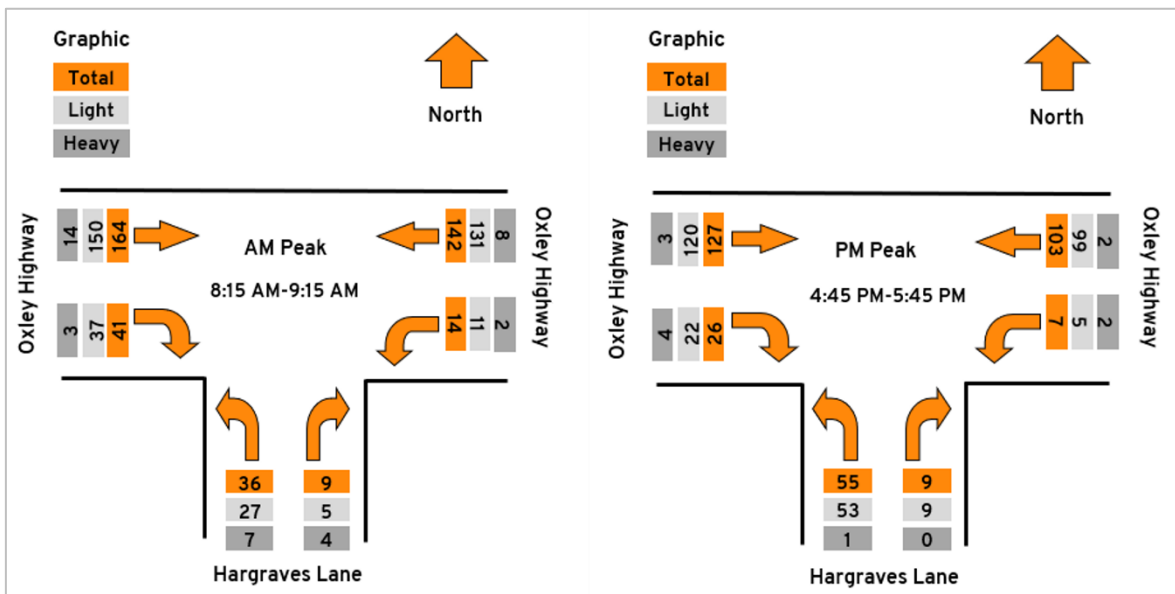

The survey results indicate that there are moderate through vehicle movements along Oxley Highway which are predominantly eastbound during the peak hours. Hargraves Lane accommodates 100 and 97 vehicles in the morning and evening peak hours respectively. Vehicles entering or exiting Hargraves Lane typically travelled to/from the western leg of Oxley Highway with fewer turning movements recorded to/from the east.



3.3.2.3 Castlereagh Highway / Federation Street

Figure 5: Castlereagh Highway / Federation Street - Turning Movement Count Peak Hour Survey Results

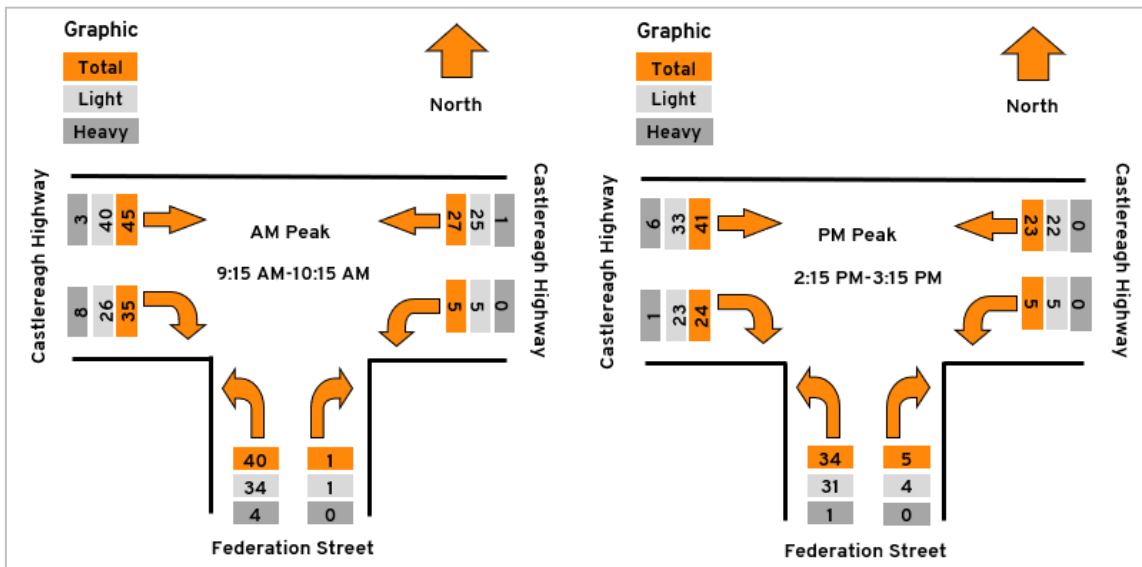

The survey results indicate the intersection currently carries a low level of traffic in the order of 153 and 132 vehicle movements in the morning and evening peak hour, respectively. The morning peak hour was recorded from 9:15am to 10:15am and the afternoon peak hour was recorded from 2:15pm to 3:15pm.

The majority of vehicle movements are through movements on Castlereagh Highway. Vehicles utilising Federation Street typically travelled to/from the west which reflects the operation of Federation Street as a bypass route near Gilgandra.

3.3.2.4 Newell Highway / Hargraves Lane

Figure 6: Newell Highway / Hargraves Lane- Turning Movement Count Peak Hour Survey Results

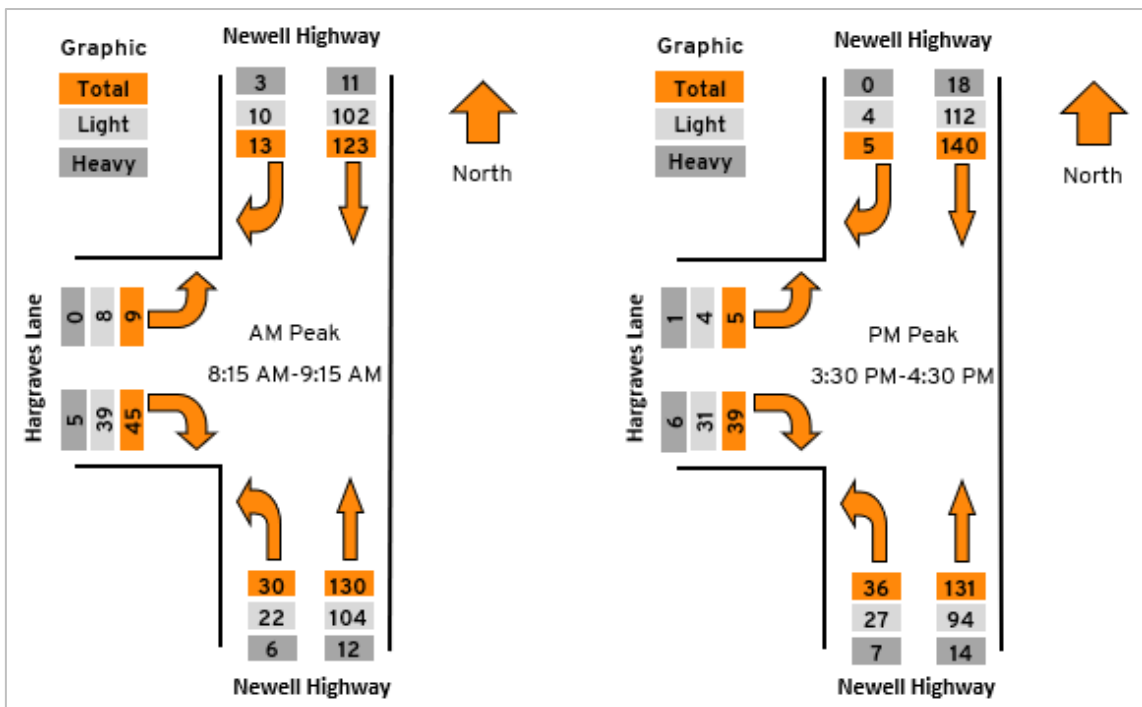

The survey results indicate that the majority of vehicle movements at the intersection are through movements along Newell Highway. Hargraves Lane also functions as a bypass route near Gilgandra which is demonstrated by the higher volumes of traffic travelling to/from the southern leg of Newell Highway. The intersection carries a moderate level of traffic in the order of 350 and 356 vehicles in the morning and evening peak hour, respectively.

3.4 Sustainable Transport

No public transport or active transport facilities are currently provided in the vicinity of the site.

3.5 Crash History

Amber has conducted a review of the TfNSW Centre for Road Safety Crash and Casualty Statistics database for all crashes within the following search area:

- Oxley Highway between Thompsons Lane and the railway level crossing in Gilgandra;
- The entire lengths of Federation Street and Hargraves Lane; and
- All respective intersections.

The crash database provides the location and severity of all injury and fatal crashes for the five-year period from 2018 to 2022. The search revealed one serious injury crash on Oxley Highway and one minor/other injury crash on Federation Street which are summarised in Table 5.

Table 5: TfNSW Crash Statistics

Road	Location	Severity	Crash Type	Date and Time	Light and Weather Conditions
Federation St	50m North of Bobs St	Minor/Other Injury	Off road to the left on right bend, hitting object	April 2019 (02:00 - 03:59)	Darkness (Fine)
Oxley Hwy	150m West of Federation St	Serious Injury	Off road to the right	February 2019 (00:01 - 01:59)	Darkness (Fine)

The crash search indicates that there are no discernible crash trends. Given the search area, associated road network classifications, and lack of discernible crash trends, it is concluded that the road network is currently operating in a relatively safe manner.



4. Planning Proposal

The Planning Proposal involves the rezoning of land at 361 Oxley Highway, Gilgandra (Lot 1 and part of Lot 2 in DP 1070081) for industrial use. The site is located to the west of the Gilgandra township and is situated on the southern side of Oxley Highway.

The site is approximately 52 hectares in size and is proposed to be rezoned from RU1 - Primary Production to E4 - General Industrial with a minimum lot size of 5,000sqm and no height limit or FSR. The northern-most 21-hectare section with frontage to the Oxley Highway is intended to be developed as a fully serviced industrial area. Gilgandra Shire Council has provided an indicative site layout for the subdivision of this section which includes construction of 27 industrial lots along with the associated internal road network. The indicative layout provided for the industrial subdivision area is shown within Figure 7 and shows that access to the site is proposed via a new priority-controlled T-intersection with Oxley Highway, approximately 143 metres east of Middleton Memorial Drive.

The proposal would provide a total of 18 hectares of industrial lots and 1.35 kilometres of new road. It is understood the industrial area is intended to be occupied by a range of potential developments as outlined in Table 6.

Table 6: Potential Developments within Industrial Area

Potential Development Types	
Agricultural machinery sales	Agricultural rural supplies
Fertilizer depots	Trucking and transport depots
Truck and machinery repairs and spares	Steel and fencing supplies
Earth moving and civil contractors	Fuel depots
Concrete batching plant	Diesel mechanics
Grain sales and storage	Grain and seed cleaning facilities
Commercial weighbridge	Auto electrical
Hardware and plumbing supplies	Car servicing and repairs
Tyre fitters	Landscape and garden supplies
Refrigeration and air conditioning fitters	Logistics and distribution facilities
Refrigerated and cold storage distribution	Truck stop / roadhouse
Rail contractor depot	Manufacturing and processing facilities

The indicative layout for the internal road network forms a single loop road with an additional dead-end section providing access to a single lot in the south-western corner. The roads are expected to be classified as local roads with a road reserve width of 22 metres including a 4 metre wide travel lane and a 4 metre wide parking lane in each direction. All lots are proposed to gain access from the internal road network.

An approved 12-hectare solar farm is to be located on the southern part of the site with access via Aralee Road however is yet to be constructed.

Figure 7: Indicative Site Layout – Northern Section (Industrial Area)



A.03 ORIGINAL	DATE	REVISION / AMENDMENT DESCRIPTION	SCALE	HORIZONTAL	VERTICAL	Gilgandra Shire Council www.gilgandra.nsw.gov.au 15, Warren Road, Gilgandra, NSW - 2827	PROJECT TITLE	DRAWING TITLE	ISSUE	Preliminary
	12/09/23	Rev 0		1: 2500	1: 2500		Proposed Industrial Subdivision 1, (Schier's Subdivision), Gilgandra Location : 361, Oxley Highway, Gilgandra, NSW 2827	Concept lot layout plan	DATE	10/10/2023
	26/09/23	Rev 1						Option 1 (with services)	SHEET NO	
	10/10/23	Rev 2						DRAWING NO: GIL/SIS/23/02		
			DESIGN BY	SP						
			DRAWN BY	SP						
			REVIEWED BY							
			CO ORDINATE SYSTEM:							
			HEIGHT DATUM:	A.H.D.						

Source: Gilgandra Shire Council



5. Traffic Assessment

5.1 Traffic Generation

The *Roads & Maritime Services Trip Generation Surveys - Business Parks and Industrial Estates Analysis Report* (Analysis Report), dated December 2012, provides guidance on traffic generating information for Business Parks and Industrial Estates. It is considered that the proposed development represents an Industrial Estate given it is proposed to accommodate large industrial and warehouse tenancies and based on the following definition provided within the Analysis Report:

'A mix of manufacturing and warehousing would be the major land uses in an Industrial Park, which is also differentiated from a Business Park by a larger site, larger lot sizes and extensive internal road network.'

The Analysis Report provides survey data for one industrial estate within a regional area which is the Port Stephens Industrial Estate in Taylors Beach. The traffic generation rate for the surveyed site is not considered to be applicable to the proposal on a per-hectare basis for the following reasons:

- The Port Stephens Industrial Estate is situated in a coastal area with close proximity to port facilities.
- The potential development types for the subject site as outlined in Table 6 are not directly comparable to those located within Port Stephens and are expected to make significant use of open space for storage of heavy machinery, agricultural equipment and other large plant.

Therefore, the traffic generation rate for the subject site has been based on the surveyed Gross Floor Area (GFA) trip rates which are outlined as follows:

- Daily vehicle trips: 3.777 trips per 100sqm GFA.
- Weekday peak hour vehicle trips: 0.392 trips per 100sqm GFA.
- Heavy vehicle traffic: 8.9% of trips.

It is noted that a vehicle trip is defined as a vehicle travelling in one direction (e.g. a vehicle accessing the site would generate one trip towards the site and another trip away from the site when it departs).

Advice from Gilgandra Shire Council indicates that based on the potential development types and indicative subdivision layout, it is estimated that each lot would accommodate an average development GFA of approximately 100sqm. Application of the above rates to the total 2,700sqm of GFA results in a future traffic generation of 102 vehicle trips per day and 11 vehicle trips in the morning and evening peak hours. The Analysis Report data indicates that the evening peak hour traffic is generally higher than the morning peak hour, however for the purposes of this assessment the peak hour rate has conservatively been adopted for both the morning and evening periods.

5.2 Trip Distribution

The Analysis Report data provides the traffic distributions for the surveyed site which are approximated as follows:

- Morning Peak: 40% outbound and 60% inbound
- Evening Peak: 65% outbound and 35% inbound

As such, the site is expected to generate the following traffic volumes during the morning and evening peak periods.

Table 7: Site Peak Hour Traffic Generation

Trip Direction	Vehicle Classification	AM Peak (vph)	PM Peak (vph)
Inbound Trips	Light Vehicles	6	4
	Heavy Vehicles	1	0
Outbound Trips	Light Vehicles	4	7
	Heavy Vehicles	0	1
Total		11	11

The traffic is expected to be distributed from the internal road network to Oxley Highway via the new priority-controlled intersection. Trip distributions have been estimated based on the proximity and size of the nearby towns as outlined in Table 6.

Table 8: Trip Distributions

Direction	Estimated Trip Proportion	Travel Route
South (Dubbo, Narromine)	80%	Newell Highway, Hargraves Lane and Oxley Highway
East (Gilgandra)	10%	Oxley Highway
North (Coonamble)	5%	Castlereagh Highway, Federation Street and Oxley Highway
West (Warren)	5%	Oxley Highway

The resulting traffic volumes expected to be generated by the site on the surrounding road network is shown within Figure 8 and Figure 9 for the morning and evening peak periods respectively. For the purposes of the assessment, it has been conservatively assumed that the peak traffic generation for the site would coincide with the peak hours on the road network.

Figure 8: Site Traffic - AM Peak Hour

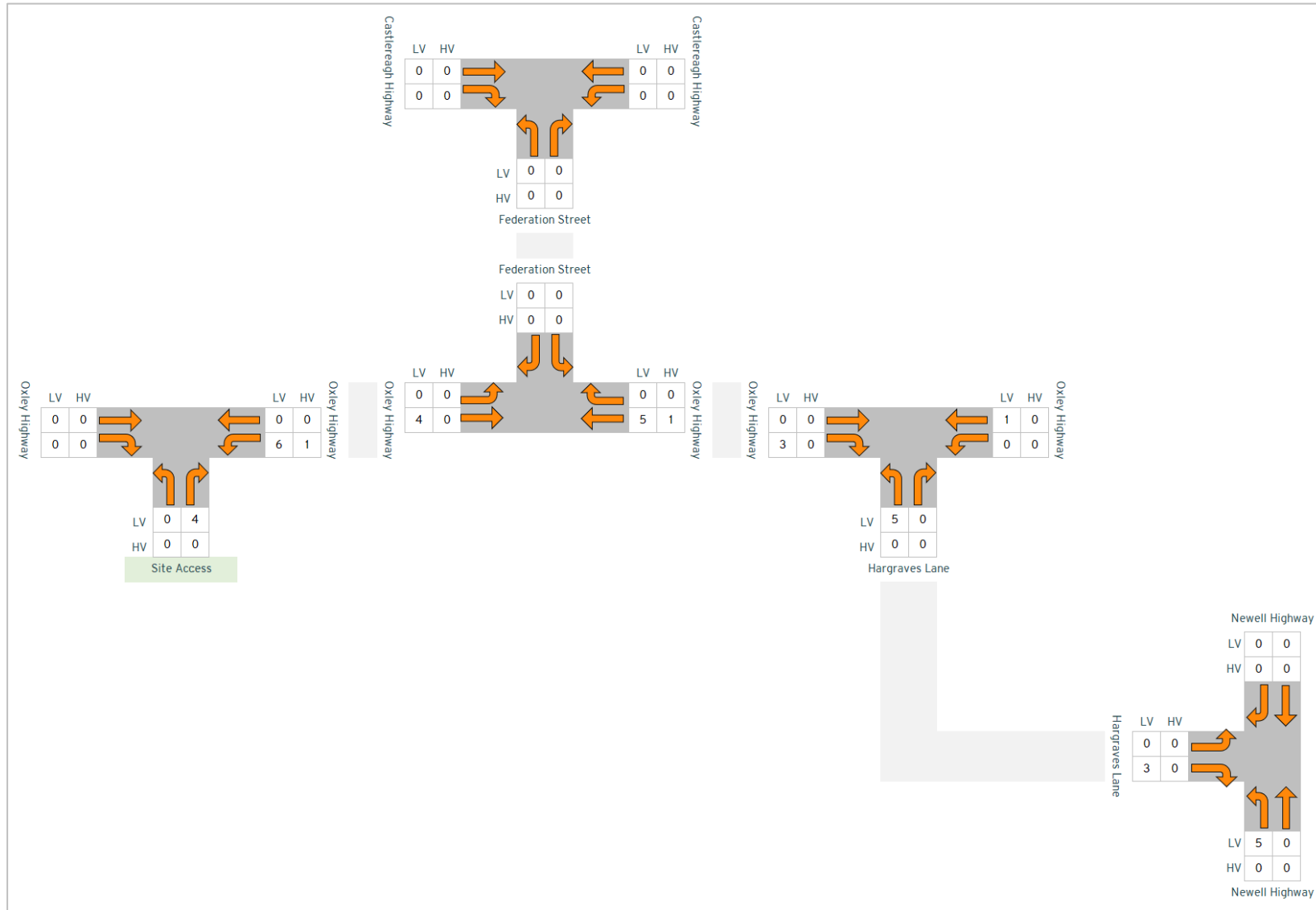
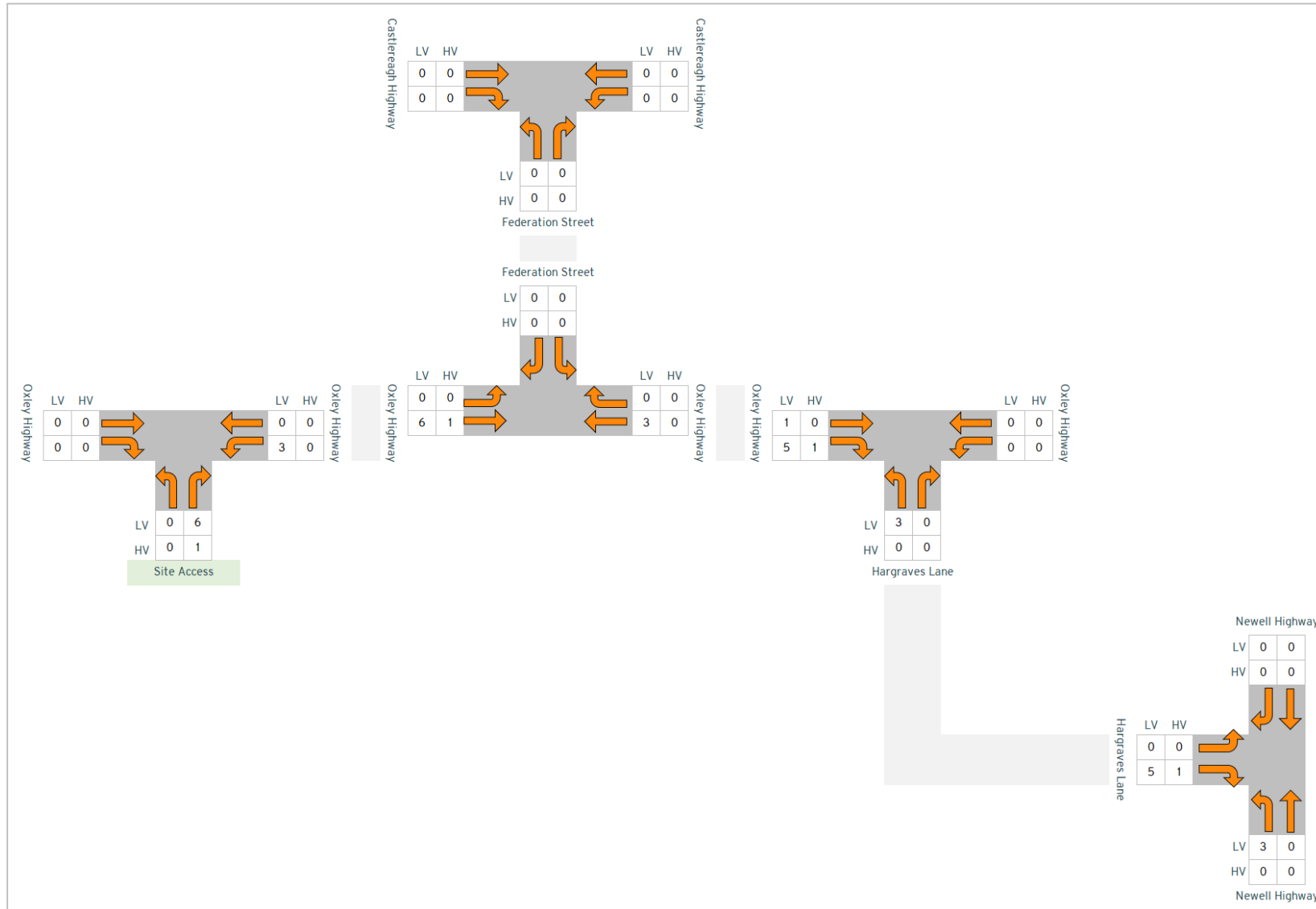

Figure 9: Site Traffic - PM Peak Hour



5.3 Cumulative Traffic Impacts

A 5MW Solar Farm development (Gilgandra 1A Solar Farm by ITP Renewables) has been approved for southern section of the site which would be accessed via Aralee Road. The peak traffic impacts of the project would occur during construction which is expected to take approximately 12 weeks. Estimated traffic volumes during the construction phase are provided in Table 9 and have been sourced from the Traffic Impact Assessment prepared for the project in November 2021 by Price Merrett Consulting.

Table 9: Gilgandra 1A 5MW Solar Farm - Construction Traffic Volumes

	Morning (6:30-8:00am)	Midday (10:00am-2:00pm)	Evening (4:00-5:00pm)	Total Daily Trips
Light Vehicles	40 (27 vph)	0	40 (40 vph)	80
Heavy Vehicles	0	6 (2 vph)	0	6
			Total	86

Traffic associated with the Solar Farm project is anticipated to travel between nearby towns to the east including Dubbo and would predominantly turn left in and right out of Aralee Road. Minimal traffic is expected during the operational phase of the project which is estimated to occur for a period of up to 35 years.

Given the short construction period and low anticipated traffic volumes, it is concluded that the cumulative traffic impacts of the project would be negligible.

5.4 Traffic Assessment

In order to determine the ability of the external road network to accommodate the traffic expected to be generated by the site, a traffic modelling exercise has been undertaken for the following intersections using the SIDRA intersection modelling software:

- Oxley Highway / Site Access;
- Oxley Highway / Federation Street;
- Oxley Highway / Hargraves Lane;
- Castlereagh Highway / Federation Street; and
- Newell Highway / Hargraves Lane.

Level of Service is a qualitative measure used to describe the operating conditions of a section of road or an intersection. Levels of Service are designated from A to F from best (free flow conditions) to worst (forced flow with stop start operation, long queues and delays) and represent the perception of the road conditions by motorists including speed and travel time, freedom to manoeuvre, traffic interruptions, comfort and convenience, and safety. The assessment of the level of service for sign-controlled intersections is based on the average delay (seconds/vehicle) of the critical movement.

The traffic modelling has been undertaken for the following scenarios:

- **Project Case:** The traffic volumes have been based on the morning and evening peak hour survey results presented within Section 2.3.2 and the proposed traffic expected to be generated by the site presented within Section 4.2.
- **20-year Future Scenario (2043):** Existing surveyed traffic volumes at each intersection have been adjusted by an estimated 1.5% compounding annual growth rate over 20 years.

The results of the analysis for each intersection are provided in the following sections.

5.4.1 Oxley Highway / Site Access

The traffic volumes used for the assessment are provided in Figure 10. The results of the analysis are provided within Appendix C and are summarised in Table 10 below. For the purposes of the assessment, the intersection has been modelled without any turn treatments.

Figure 10: Oxley Highway / Site Access – Traffic Modelling Volumes

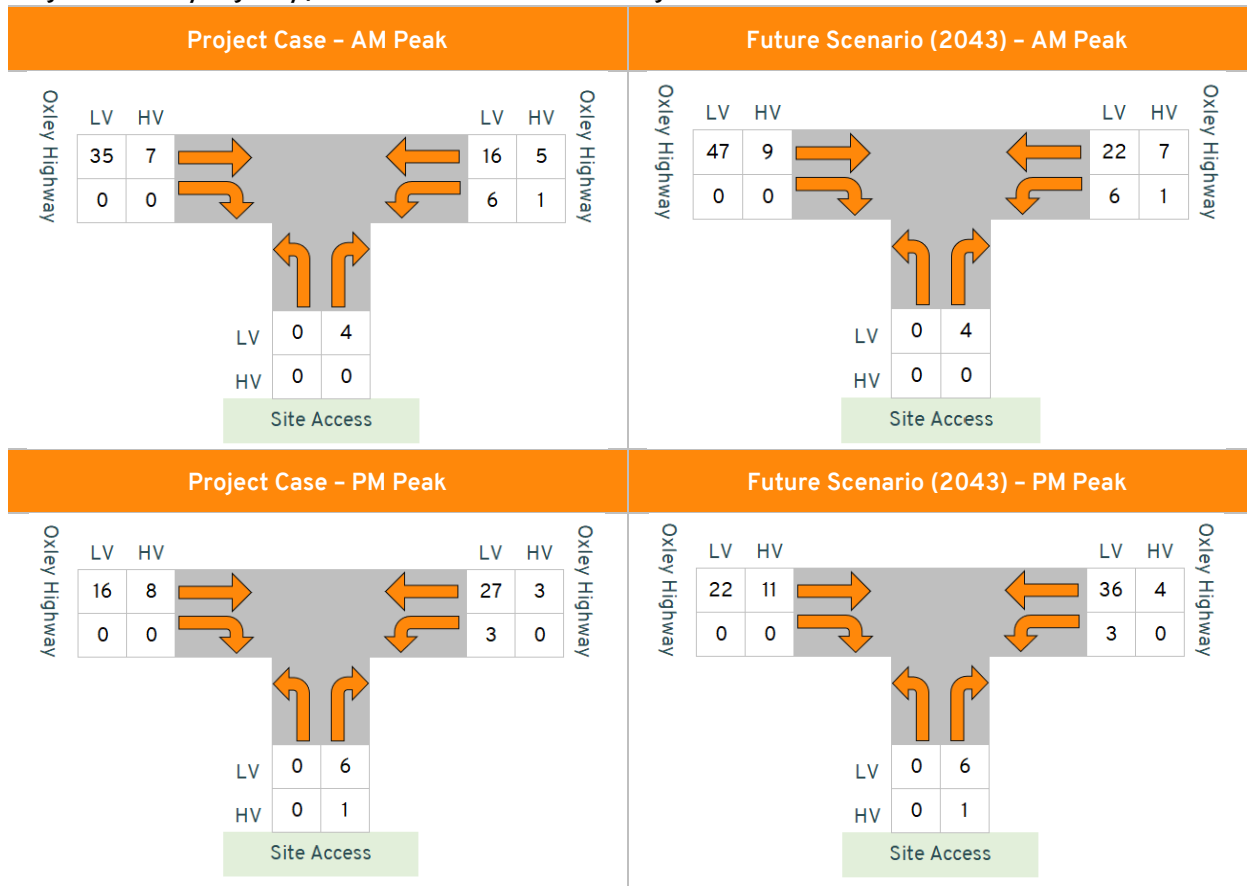

Table 10: Oxley Highway / Site Access - SIDRA Results Summary

Peak Hour	Project Case			Future Scenario (2043)		
	Average Delay (sec)	95% Queue (m)	Level of Service	Average Delay (sec)	95% Queue (m)	Level of Service
AM Peak	1.0	0.1	A	0.8	0.1	A
PM Peak	1.0	0.2	A	0.8	0.2	A

The SIDRA analysis indicates the following:

- The intersection is expected to operate with minimal queue lengths on all legs;
- The worst-case average delay at the intersection is 1.0 second; and
- The intersection is expected to operate with a good level of service.

Overall, the proposed site access intersection on Oxley Highway is expected to operate with a good level of service with minimal queue lengths or delays.

5.4.2 Oxley Highway / Federation Street

The traffic volumes used for the assessment are provided in Figure 11. The results of the analysis are provided within Appendix C and are summarised in Table 11 below.

Figure 11: Oxley Highway / Federation Street – Traffic Modelling Volumes

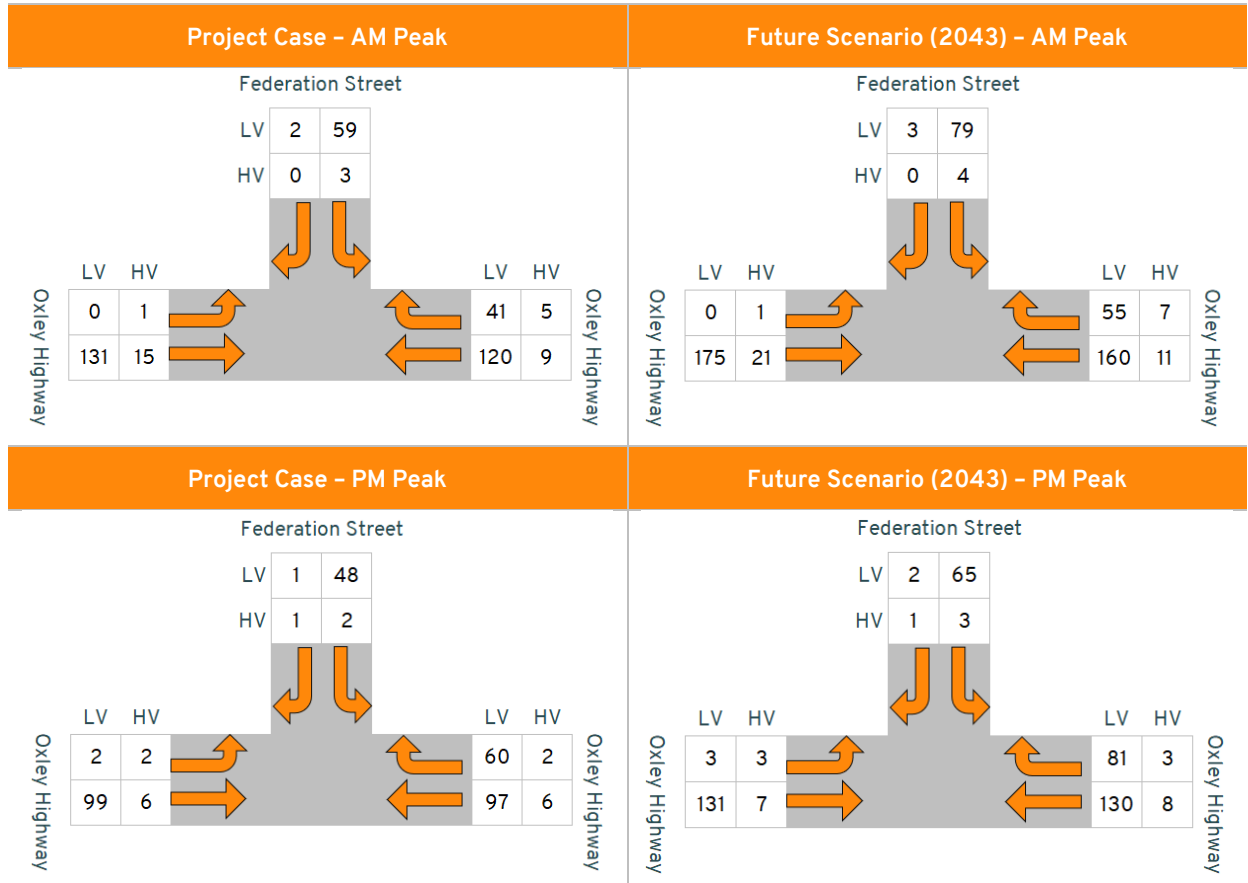

Table 11: Oxley Highway / Federation Street - SIDRA Results Summary

Peak Hour	Project Case			Future Scenario (2043)		
	Average Delay (sec)	95% Queue (m)	Level of Service	Average Delay (sec)	95% Queue (m)	Level of Service
AM Peak	1.7	2.5	A	1.8	3.6	A
PM Peak	2.1	2.7	A	2.2	3.9	A

The SIDRA analysis indicates the following:

- The intersection is expected to operate with minimal queue lengths on all legs;
- The worst-case average delay at the intersection is 2.2 seconds; and
- The intersection is expected to operate with a good level of service.

Overall, the intersection of Oxley Highway and Federation Street is expected to operate with a good level of service with minimal queue lengths or delays.

5.4.3 Oxley Highway / Hargraves Lane

The traffic volumes used for the assessment are provided in Figure 12. The results of the analysis are provided within Appendix C and are summarised in Table 12 below.

Figure 12: Oxley Highway / Hargraves Lane - Traffic Modelling Volumes

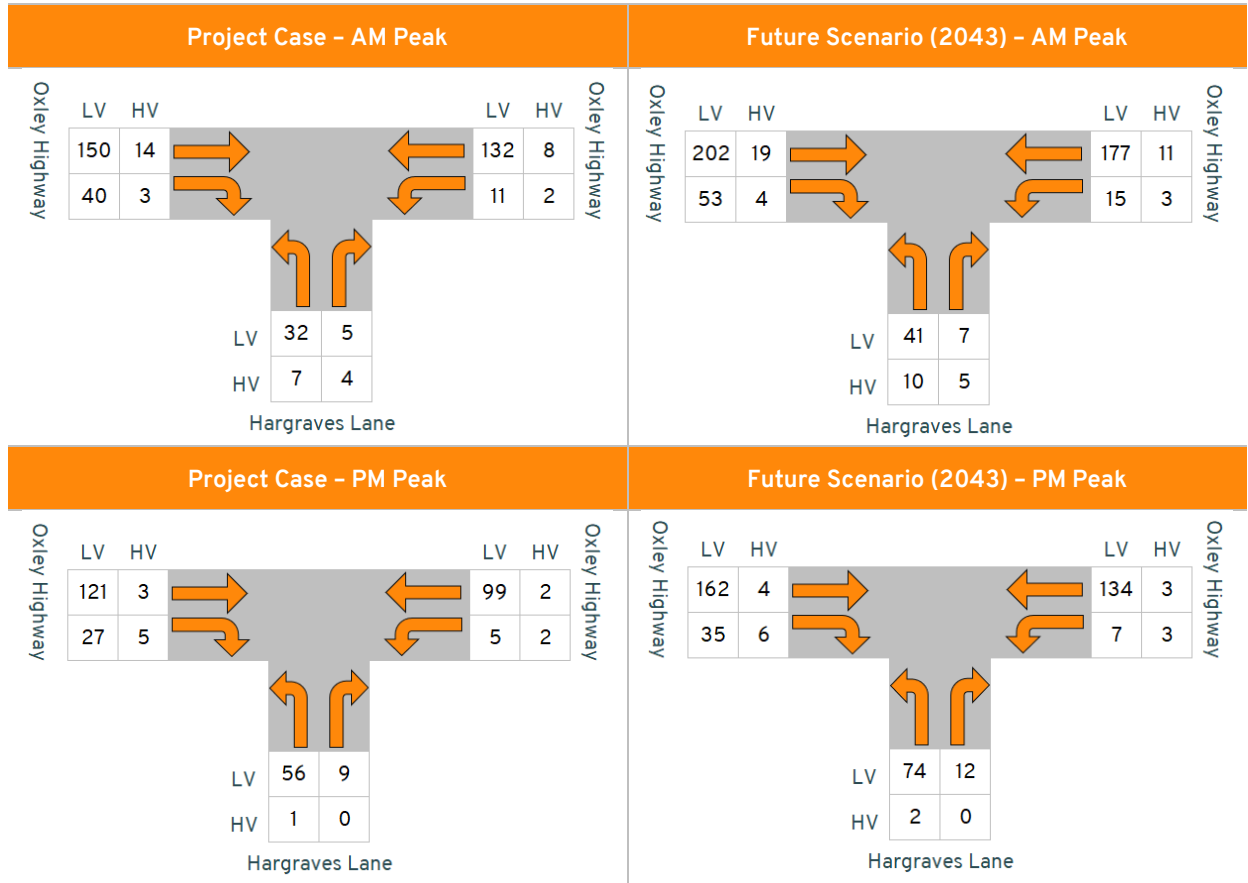

Table 12: Oxley Highway / Hargraves Lane - SIDRA Results Summary

Peak Hour	Project Case			Future Scenario (2043)		
	Average Delay (sec)	95% Queue (m)	Level of Service	Average Delay (sec)	95% Queue (m)	Level of Service
AM Peak	1.7	2.4	A	2.0	1.7	A
PM Peak	2.0	1.7	A	2.0	2.3	A

The SIDRA analysis indicates the following:

- The intersection is expected to operate with minimal queue lengths on all legs;
- The worst-case average delay at the intersection is 2.0 seconds; and
- The intersection is expected to operate with a good level of service.

Overall, the intersection of Oxley Highway and Hargraves Lane is expected to operate with a good level of service with minimal queue lengths or delays.

5.4.4 Castlereagh Highway / Federation Street

The traffic volumes used for the assessment are provided in Figure 13. The results of the analysis are provided within Appendix C and are summarised in Table 13 below.

Figure 13: Castlereagh Highway / Federation Street - Traffic Modelling Volumes

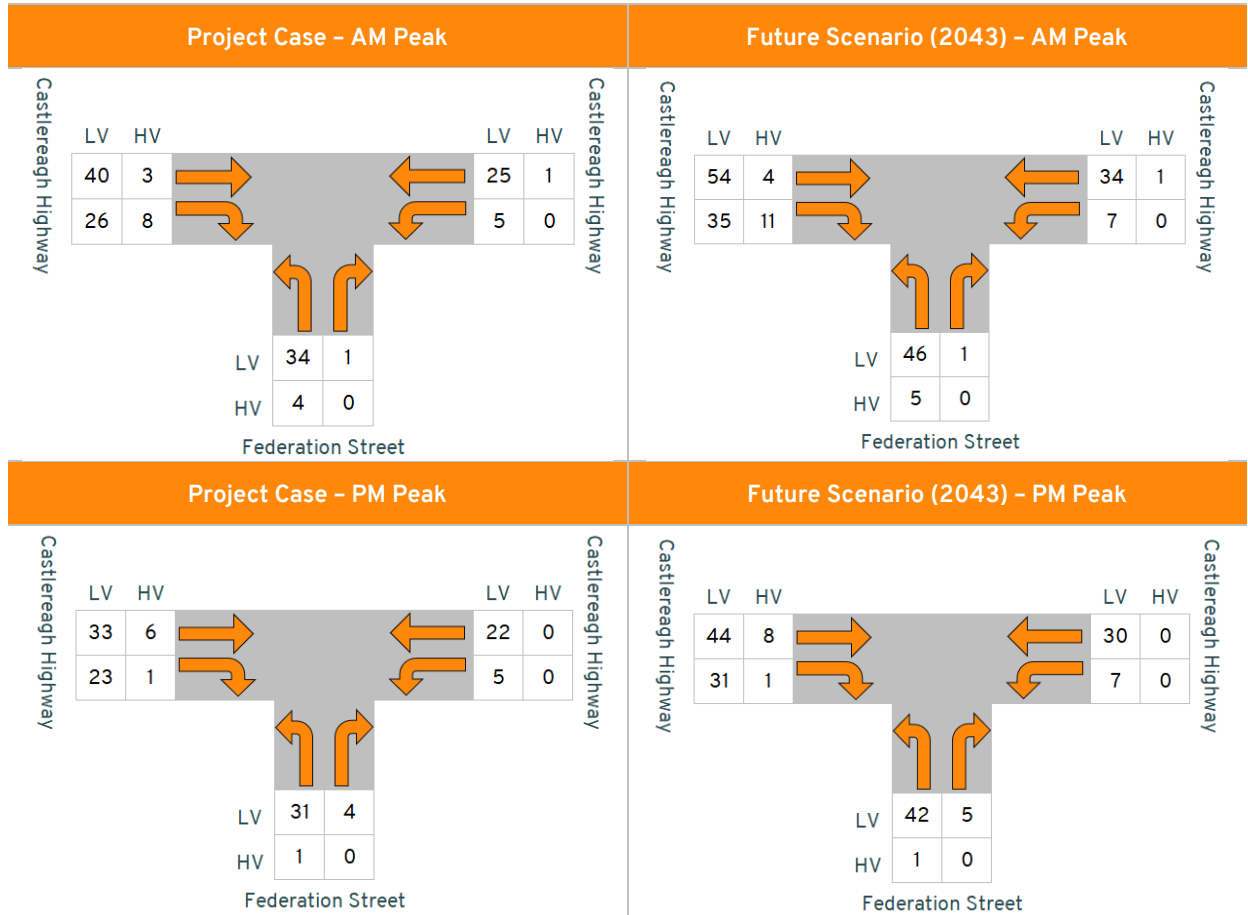

Table 13: Castlereagh Highway / Federation Street - SIDRA Results Summary

Peak Hour	Project Case			Future Scenario (2043)		
	Average Delay (sec)	95% Queue (m)	Level of Service	Average Delay (sec)	95% Queue (m)	Level of Service
AM Peak	4.5	0.8	A	4.5	1.1	A
PM Peak	4.5	0.7	A	4.5	0.9	A

The SIDRA analysis indicates the following:

- The intersection is expected to operate with minimal queue lengths on all legs;
- The worst-case average delay at the intersection is 4.5 seconds; and
- The intersection is expected to operate with a good level of service.

Overall, the intersection of Castlereagh Highway and Federation Street is expected to operate with a good level of service with minimal queue lengths or delays.

5.4.5 Newell Highway / Hargraves Lane

The traffic volumes used for the assessment are provided in Figure 14. The results of the analysis are provided within Appendix C and are summarised in Table 14 below.

Figure 14: Newell Highway / Hargraves Lane - Traffic Modelling Volumes

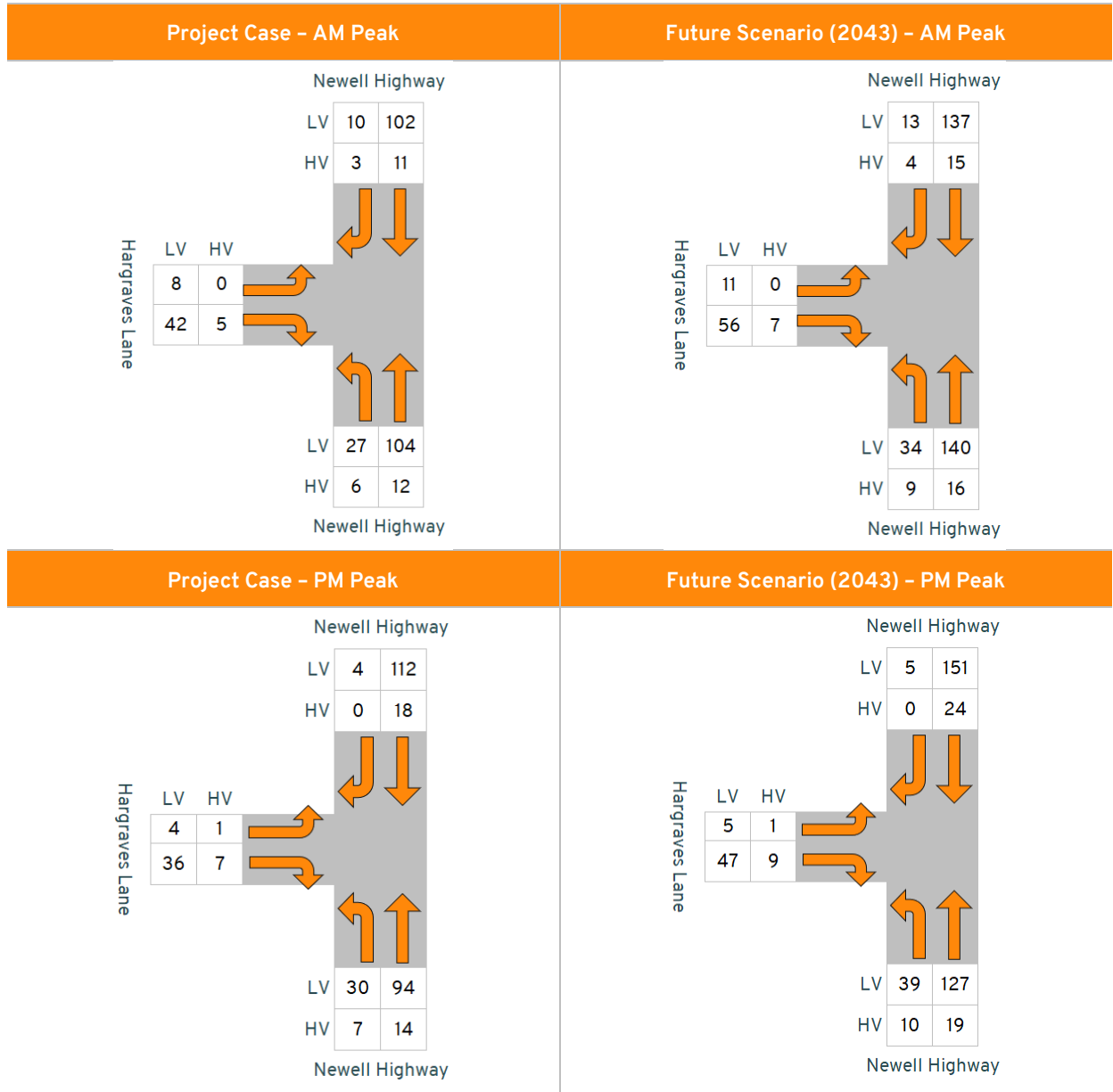

Table 14: Newell Highway / Hargraves Lane - SIDRA Results Summary

Peak Hour	Project Case			Future Scenario (2043)		
	Average Delay (sec)	95% Queue (m)	Level of Service	Average Delay (sec)	95% Queue (m)	Level of Service
AM Peak	1.9	1.5	A	2.1	2.2	A
PM Peak	1.7	1.4	A	1.7	2.1	A



The SIDRA analysis indicates the following:

- The intersection is expected to operate with minimal queue lengths on all legs;
- The worst-case average delay at the intersection is 2.1 seconds; and
- The intersection is expected to operate with a good level of service.

Overall, the intersection of Newell Highway and Hargraves Lane is expected to operate with a good level of service with minimal queue lengths or delays.

5.5 Summary

Overall, the traffic generated by the industrial land use is expected to have a minor impact on the operation of the existing road network given the existing low level of traffic on the road network. The modelling exercise suggests that the delays and queue lengths at all nearby intersections including the proposed site access on Oxley Highway are minimal. Therefore, the proposal is not expected to create any adverse traffic impacts on the road network.

6. Access and Internal Road Layout

6.1 Road Alignment

Access to the industrial area is expected via a new priority-controlled T-intersection with Oxley Highway, approximately 143 metres east of Middleton Memorial Drive. The indicative layout for the internal road network provides a single loop road with an additional dead-end section approximately 120m in length which provides access to a single lot in the south-western corner.

It is recommended that a future review of the internal road layout is provided to ensure that vehicles are able to suitably circulate within the site. It is also recommended that a turning head is provided at the end of the dead-end road to allow vehicles to turn around. The turning head should be designed to allow for waste vehicles and suitable signage should be installed to prevent larger trucks entering the road unless associated with the adjacent lot.

6.2 Road Design

The following provides a review of the proposal against the traffic and transport related requirements for 'Industrial Subdivision' within Chapter 5.3 of the *Gilgandra Shire Development Control Plan (DCP)*:

- It is recommended that the internal roads are designed to allow two 26 metre B-Doubles to pass each other as well as access for 35.4 metre B-Triples which are the largest vehicles anticipated to utilise the site.
- Lot sizes are sufficient to allow trucks to manoeuvre on-site without reversing onto or off the lot.
- Vehicular access from allotments to a public road are capable of complying with the provisions of AS2890.1 Parking Facilities – Off Street Car parking and the RTA's Guidelines for Traffic Generating Development.
- No direct vehicular access to major roads is provided from within individual lots.

Accordingly, the internal roads are considered to be designed in accordance with the requirements of the DCP and are expected to be able to accommodate the vehicle trips generated by the proposed industrial use within the site.

6.3 Intersection Design

6.3.1 Site Access

The requirement to provide turn facilities at the access on Oxley Highway is primarily generated during the morning peak hour when the highest proportion of vehicle movements would be toward the site. A design speed of 90km/hr has been adopted for the assessment based on the 80km/hr speed limit and vehicle speeds recorded during the tube count survey presented in Section 3.3.1.

Austrroads Guide to Traffic Management Part 6: Intersections, Interchanges, and Crossings specifies the turning treatments required at intersections. Figure 3.25 of the guide specifies the required turn treatments on the major road at unsignalised intersections and is provided below in Figure 15 for a design speed between 70km/hr and 100km/hr.

Figure 15: Figure 3.25 of Austroads Guide to Traffic Management Part 6

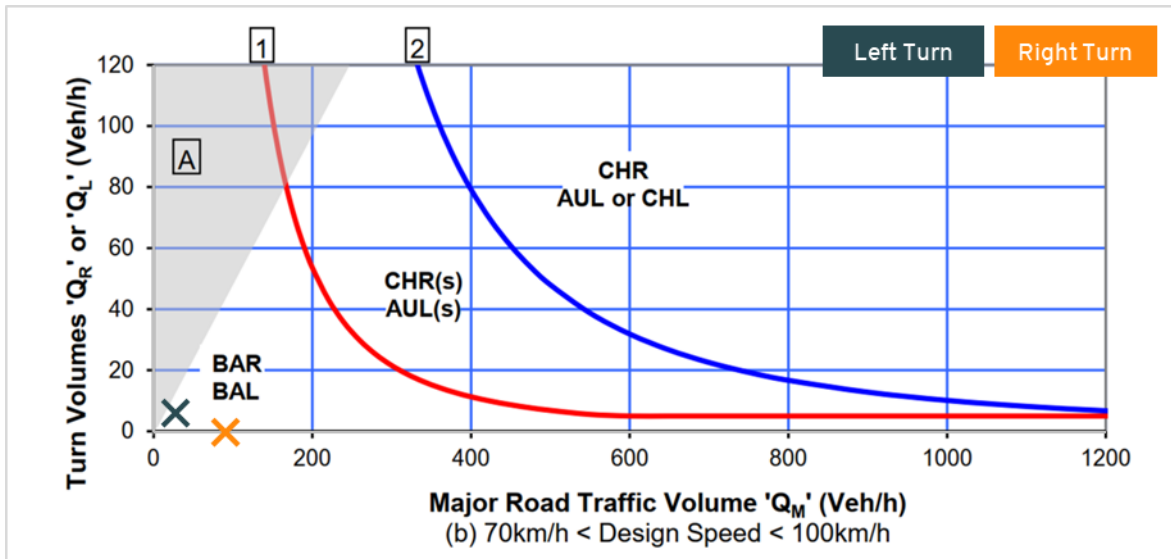

Table 15 identifies the required turning treatments based on the estimated 20-year future traffic volumes at the site access provided in Figure 10. The volumes have been plotted within Figure 15 above.

Table 15: Turning Volumes for Turn Treatment Calculations – Oxley Highway / Site Access

Turning Treatment	Traffic Volume (vph)		Requirement
	Turn Volume	Major Road	
Right Turn	0	91	BAR
Left Turn	6	28	BAL

Therefore, the intersection would require a Basic Left Turn (BAL) and Basic Right Turn (BAR) treatment. *Austroads Guide to Traffic Management Part 4A: Unsignalised and Signalised Intersections* specifies the following within Section 8.2.5:

In situations where there are significant numbers of vehicles, particularly heavy vehicles making a left turn from the major road at an intersection with an auxiliary left-turn treatment, restricting sight distance for vehicles turning out of the minor road, particularly right-turning vehicles, offsetting the left-turn lane from the adjacent through lane on the minor road improves the sight distance for vehicles turning out of the minor road. In particular, the sight distance to vehicles following a left-turning vehicle can be substantially improved. An offset left-turn lane should therefore be considered at an intersection where sight distance past left-turning vehicles may improve the intersection safety.

The factors that may warrant the use of an offset rural channelised left-turn lane include:

- high through traffic volumes on the major road
- high proportion / number of vehicles (particularly heavy vehicles) turning left from the major road
- the capacity of the turning movements from the minor road and resultant delays to vehicles
- intersection geometry and sight lines.

It is proposed to provide a BAR and Channelised Left Turn (CHL) treatment to improve intersection safety and accommodate turning traffic including heavy vehicles. The proposed layout for the site access intersection including the BAR and CHL turn treatments is shown in Appendix D.

In order to confirm the intersection can accommodate 26 metre B-Doubles and 35.4 metre B-Triples a swept path assessment has been provided within Appendix E using the Autodesk Vehicle Tracking software. The assessment demonstrates that the vehicles are able to suitably turn to/from Oxley Highway with the inclusion of the proposed turn treatments. Accordingly, it is concluded that the intersection has been suitably designed and is able to accommodate the vehicles expected to access the site.

6.3.2 Internal Road Network

The internal road network provides two T-intersections which are proposed to be priority-controlled. It is recommended that the internal road network is designed to accommodate simultaneous two-way vehicle movement by B-Doubles and access by B-Triples.

6.4 Sight Distance

Austrroads Guide to Road Design Part 4A: Unsignalised and Signalised Intersections specifies the Safe Intersection Sight Distance (SISD) as the minimum sight distance which should be provided along the major road at any intersection. Table 3.1 of the guide specifies the SISD required for various design speeds.

A design speed of 90km/hr has been assumed for Oxley Highway which requires an SISD of 214 metres based on a reaction time of 2.0 seconds. The available sight distance at the intersection exceeds the requirements of the Austrroads Guide given the relatively flat and straight alignment of the road network as illustrated within Figure 16.

Accordingly, vehicles are expected to be able to safely enter Oxley Highway from the site.

It is recommended that an assessment of the sight distance at the internal road intersections is undertaken to ensure the required sight distance is provided in all directions in accordance with the requirements of the Austrroads Guidelines.

6.5 Lot Access

All lots are proposed to gain access from the internal loop road with a dead-end access road proposed in the southwestern corner of the site to provide access to Lot 21. A review of the lot layout indicates suitable access locations are able to be provided in accordance with Figure 3.3 of AS 2890.2:2018.

Figure 16: Sight Distance - Oxley Highway / Site Access

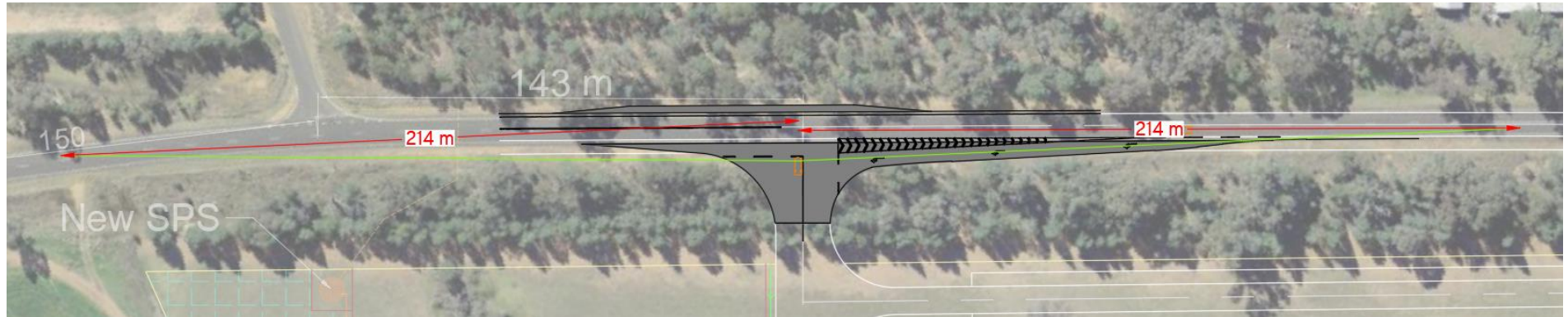

7. Railway Level Crossing Impacts

A railway level crossing is located approximately 2 kilometres east of the site on Oxley Highway adjacent to Gilgandra Station. The level crossing is provided with signals and warning signage however no boom gate is installed.

The following provides a summary of the key traffic features of the level crossing in relation to the Planning Proposal:

Traffic Volumes:

- The current AADT at the level crossing is in the order of 2,559 vehicles per day based on survey data collected in April 2023;
- The level crossing is expected to experience an increase in traffic volumes in the order of 10 vehicles per day; and
- The level crossing is expected to accommodate in the order of 2,569 vehicles per day following development of the site which represents an increase of approximately 0.4%.

Heavy Vehicles:

- The survey data indicates the level crossing currently accommodates in the order of 5.7% heavy vehicles, which represents 146 heavy vehicles per day;
- The level crossing is expected to experience an increase in heavy vehicle traffic of approximately 1 vehicle per day;
- With the site traffic, the level crossing is expected to accommodate in the order of 147 heavy vehicles per day; and
- The level crossing is expected to accommodate in the order of 5.7% heavy vehicles following development of the site. Overall, there is no significant increase expected in the percentage of heavy vehicles utilising the level crossing.

Road Safety:

- No crashes have been recorded at the railway level crossing between 2018-2022 based on the TfNSW Centre for Road Safety Crash and Casualty Statistics database;
- The SIDRA analysis presented within Sections 5.4.2 and 5.4.3 indicates queue lengths at the nearby key intersections along Oxley Highway are not expected to extend back to the level crossing; and
- A pedestrian crossing facility is provided at the railway level crossing with fencing and warning signage.

Based on the above assessment, the proposed increase in traffic generated by the proposal is not expected to have a notable impact on the operation of the railway level crossing.

8. Car/Bicycle Parking and Loading Facilities

It is recommended that all car and bicycle parking and loading facilities are provided in accordance with the requirements of the DCP.

Car parking is proposed to be provided within the individual sites. The lots are considered to be a sufficient size to accommodate the parking requirements on-site. In addition, the carriageway width of the internal road network allows for two-way traffic and on-street parallel parking. The on-street spaces will be available to service the needs of visitors and staff within the subdivision. Accordingly, the proposal is not expected to generate any parking impacts and the parking demand can be readily accommodated internally within the site.

All loading and unloading activities are to take place wholly within the on-site loading bays at all times. No loading or unloading activities are to take place within the road reserve.

9. Alternative Transport Modes

The internal roads are expected to be designed to accommodate buses in the event a future bus route is proposed to service the site. It is recommended that footpaths are provided on both sides of all internal roads to accommodate any pedestrian demands within the site.

10. Conclusion

Amber has reviewed the traffic and parking matters of the Planning Proposal which involves the rezoning of land at 361 Oxley Highway, Gilgandra, for industrial use.

The site is approximately 52 hectares in size and is proposed to be rezoned from RU1 - Primary Production to E4 - General Industrial with a minimum lot size of 5,000sqm and no height limit or Floor Space Ratio (FSR). The northern-most 21-hectare section with frontage to the Oxley Highway is intended to be developed as a fully serviced industrial area. Gilgandra Shire Council has provided an indicative site layout for the subdivision of this section which includes construction of 27 industrial lots along with the associated internal road network. Access is expected to be provided via a new priority-controlled intersection with Oxley Highway.

An approved 12-hectare solar farm is to be located on the southern part of the site with access via Aralee Road however is yet to be constructed.

Based on the above assessment, it is concluded that:

- The proposal will generate approximately 11 vehicle trips during each of the morning and evening peak periods which can be accommodated on the road network based on the SIDRA analysis. Further, the proposed site access intersection is expected to operate with a good level of service.
- It is recommended that the internal road layout is suitably designed to provide appropriate sight distance and allow vehicles to circulate within the site. It is also recommended that a cul-de-sac is provided at the end of the dead-end road to allow vehicles to turn around.
- It is proposed to provide BAR and CHL turn treatments at the site access on Oxley Highway as shown in Appendix D.
- The site access has been designed to provide suitable sight distance in accordance with the Austroads Guidelines.
- The increase in traffic movements is not expected to generate any notable safety issues at the railway level crossing on Oxley Highway near the Gilgandra Railway Station.
- Car and bicycle parking and loading facilities for the individual lots are to be provided in accordance with the DCP, with on-street parking provided for visitors.
- It is expected that the internal roads would be designed to accommodate buses in the event a future bus route is proposed to service the site. It is recommended that footpaths are provided on both sides of all internal roads to accommodate any pedestrian demands within the site.

Overall, it is concluded the car parking and traffic demands generated by the proposal can be readily accommodated on the surrounding road network.

Appendix A

Oxley Highway – Survey Results



Oxley Highway near Depot
Near Council Depot for TIA Industrial
Subdivision

GPS Coordinates(-31.706262, 148.633564)

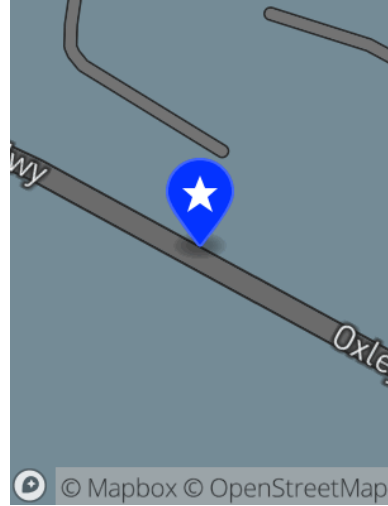

Virtual Day Class/Volume Matrix Weekday(2023)

	West							East							Both directions						
	Light	Medium	Heavy	Cycle	MotorCycle	Unclassifiable	Total	Light	Medium	Heavy	Cycle	MotorCycle	Unclassifiable	Total	Light	Medium	Heavy	Cycle	MotorCycle	Unclassifiable	Total
00:00 - 01:00	1	0	1	0	0	0	2	1	0	1	0	0	0	2	2	0	2	0	0	0	4
01:00 - 02:00	1	0	1	0	0	0	2	1	0	0	0	0	0	1	2	0	1	0	0	0	3
02:00 - 03:00	1	0	0	0	0	0	1	1	0	0	0	0	0	1	2	0	0	0	0	0	2
03:00 - 04:00	1	0	0	0	0	0	1	0	0	2	0	0	0	2	1	0	2	0	0	0	3
04:00 - 05:00	2	0	0	0	0	0	2	1	0	1	0	0	0	2	3	0	1	0	0	0	4
05:00 - 06:00	2	0	1	0	0	0	3	1	0	1	0	0	0	2	3	0	2	0	0	0	5
06:00 - 07:00	5	1	1	0	0	0	7	4	0	0	0	0	0	4	9	1	1	0	0	0	11
07:00 - 08:00	8	1	2	0	0	0	11	10	0	1	0	0	0	11	18	1	3	0	0	0	22
08:00 - 09:00	14	4	3	0	0	0	21	17	2	1	0	0	0	20	31	6	4	0	0	0	41
09:00 - 10:00	16	2	3	0	0	0	21	35	5	2	0	0	0	42	51	7	5	0	0	0	63
10:00 - 11:00	18	1	3	0	0	0	22	21	3	4	0	0	0	28	39	4	7	0	0	0	50
11:00 - 12:00	17	2	3	0	0	0	22	16	3	4	0	0	0	23	33	5	7	0	0	0	45
12:00 - 13:00	21	1	4	0	0	0	26	21	2	4	0	0	0	27	42	3	8	0	0	0	53
13:00 - 14:00	19	3	2	0	0	0	24	18	3	3	0	0	0	24	37	6	5	0	0	0	48
14:00 - 15:00	17	1	3	0	0	0	21	14	2	3	0	0	0	19	31	3	6	0	0	0	40
15:00 - 16:00	15	2	4	0	0	0	21	17	2	3	0	0	0	22	32	4	7	0	0	0	43
16:00 - 17:00	19	3	2	0	0	0	24	17	2	4	0	0	0	23	36	5	6	0	0	0	47
17:00 - 18:00	27	1	2	0	0	0	30	16	5	3	0	0	0	24	43	6	5	0	0	0	54
18:00 - 19:00	31	1	1	0	0	0	33	16	2	2	0	0	0	20	47	3	3	0	0	0	53
19:00 - 20:00	14	1	2	0	0	0	17	12	1	3	0	0	0	16	26	2	5	0	0	0	33
20:00 - 21:00	11	1	2	0	0	0	14	6	0	2	0	0	0	8	17	1	4	0	0	0	22
21:00 - 22:00	9	0	1	0	0	0	10	8	0	1	0	0	0	9	17	0	2	0	0	0	19
22:00 - 23:00	3	0	1	0	0	0	4	3	1	0	0	0	0	4	6	1	1	0	0	0	8
23:00 - 00:00	2	0	1	0	0	0	3	2	0	1	0	0	0	3	4	0	2	0	0	0	6
All day (0-24)	274	25	43	0	0	0	342	258	33	46	0	0	0	337	532	58	89	0	0	0	679

Classification Speed Matrix, Absolute Volume(2023)

	West							East							Both directions						
	Light	Medium	Heavy	Cycle	MotorCycle	Unclassifiable	Total	Light	Medium	Heavy	Cycle	MotorCycle	Unclassifiable	Total	Light	Medium	Heavy	Cycle	MotorCycle	Unclassifiable	Total
Under 10 km/h	1	1	0	0	0	0	2	1	0	0	0	0	0	1	2	1	0	0	0	0	3
10 - 20 km/h	0	0	0	1	0	0	1	1	0	0	1	0	1	3	1	0	0	2	0	1	4
20 - 30 km/h	0	1	0	0	0	0	1	2	1	0	0	0	0	3	2	2	0	0	0	0	4
30 - 40 km/h	3	0	0	0	0	0	3	5	1	0	0	0	0	6	8	1	0	0	0	0	9
40 - 50 km/h	11	8	1	0	0	0	20	25	8	1	0	0	0	34	36	16	2	0	0	0	54
50 - 60 km/h	66	9	2	2	1	0	80	158	28	14	0	0	1	201	224	37	16	2	1	1	281
60 - 70 km/h	273	43	26	1	3	0	346	399	50	69	0	4	2	524	672	93	95	1	7	2	870
70 - 80 km/h	1006	58	130	0	6	0	1200	950	95	163	0	2	0	1210	1956	153	293	0	8	0	2410
80 - 90 km/h	646	46	124	0	2	0	818	393	62	65	0	2	0	522	1039	108	189	0	4	0	1340
90 - 100 km/h	178	7	33	0	2	0	220	127	11	16	0	1	0	155	305	18	49	0	3	0	375
100 - 110 km/h	49	1	0	0	2	0	52	58	6	0	0	1	0	65	107	7	0	0	3	0	117
> 110 km/h	14	1	0	0	0	0	15	18	2	0	0	0	0	20	32	3	0	0	0	0	35

Appendix B

Intersection Turning Movement Surveys



Oxley Hwy & Federation St

Movement	Federation St														Vehicles	Cycle	EB	WB		
	Nth App - Left				Nth App - Right				Nth App - U Turn				Nth Total						Peds	
	Light	Bus	Rapid Heavy	Artic. Heavy	Light	Bus	Rapid Heavy	Artic. Heavy	Light	Bus	Rapid Heavy	Artic. Heavy	Total	Cyclist					Total	EB
06:00 - 06:15	4	0	1	0	0	0	0	0	0	0	0	0	0	5	1	1	0			
06:15 - 06:30	1	0	0	0	0	0	0	0	0	0	0	0	0	4	0	1	1			
06:30 - 06:45	7	0	0	0	0	0	0	0	0	0	0	0	0	7	0	0	0			
06:45 - 07:00	5	0	0	0	0	0	0	0	0	0	0	0	0	5	0	0	0			
07:00 - 07:15	5	0	0	0	0	0	0	0	0	0	0	0	0	5	0	0	0			
07:15 - 07:30	10	0	0	0	0	0	0	0	0	0	0	0	0	10	0	0	1			
07:30 - 07:45	9	0	0	0	0	0	0	0	0	0	0	0	0	10	0	0	0			
07:45 - 08:00	15	0	0	0	0	0	0	0	0	0	0	0	0	17	0	0	0			
08:00 - 08:15	12	0	1	2	1	16	0	0	0	0	0	0	0	16	0	0	0			
08:15 - 08:30	14	0	0	1	15	1	0	0	0	0	0	0	0	15	1	0	0			
08:30 - 08:45	11	0	0	0	11	1	0	0	0	0	0	0	0	12	0	1	0			
08:45 - 09:00	21	0	0	0	21	1	0	0	0	0	0	0	0	22	0	0	0			
09:00 - 09:15	13	2	0	0	15	0	0	0	0	0	0	0	0	15	0	0	0			
09:15 - 09:30	7	0	0	0	7	1	0	0	0	0	0	0	0	8	0	0	1			
09:30 - 09:45	13	0	2	0	15	0	0	0	0	0	0	0	0	15	0	0	0			
09:45 - 10:00	10	0	1	0	11	1	0	0	0	0	0	0	0	12	1	0	0			
10:00 - 10:15	9	0	1	0	10	1	0	0	0	0	0	0	0	12	1	1	0			
10:15 - 10:30	14	0	1	2	17	3	1	0	0	0	0	0	0	18	3	0	0			
10:30 - 10:45	8	1	2	0	11	1	0	0	0	0	0	0	0	11	1	0	0			
10:45 - 11:00	8	0	0	2	10	3	0	0	0	0	0	0	0	13	0	1	0			
11:00 - 11:15	7	0	1	1	9	0	0	0	0	0	0	0	0	10	0	0	1			
11:15 - 11:30	14	0	1	0	15	0	0	0	0	0	0	0	0	15	0	0	0			
11:30 - 11:45	13	0	1	1	15	3	0	0	0	0	0	0	0	18	0	0	0			
11:45 - 12:00	4	0	0	0	4	1	1	0	0	0	0	0	0	5	1	0	0			
12:00 - 12:15	7	0	0	2	9	0	0	0	0	0	0	0	0	9	0	1	0			
12:15 - 12:30	5	0	0	0	5	2	0	0	0	0	0	0	0	8	0	0	0			
12:30 - 12:45	8	0	2	0	10	0	0	0	0	0	0	0	0	11	0	0	0			
12:45 - 13:00	5	0	0	0	5	1	0	0	0	0	0	0	0	7	0	0	0			
13:00 - 13:15	6	0	2	0	8	0	0	0	0	0	0	0	0	9	0	0	0			
13:15 - 13:30	8	0	2	0	10	1	1	0	0	0	0	0	0	12	2	0	0			
13:30 - 13:45	7	0	0	0	7	0	0	0	0	0	0	0	0	8	0	0	0			
13:45 - 14:00	9	0	0	0	9	0	0	0	0	0	0	0	0	9	0	0	0			
14:00 - 14:15	5	0	0	0	5	2	0	0	0	0	0	0	0	7	0	1	2			
14:15 - 14:30	12	0	1	0	13	1	0	0	0	0	0	0	0	15	0	0	0			
14:30 - 14:45	10	0	0	0	11	0	0	0	0	0	0	0	0	12	0	0	1			
14:45 - 15:00	16	0	1	0	17	2	0	0	0	0	0	0	0	19	0	0	1			
15:00 - 15:15	15	0	0	0	15	1	0	0	0	0	0	0	0	16	0	0	0			
15:15 - 15:30	10	0	0	0	10	1	0	0	0	0	0	0	0	12	1	0	1			
15:30 - 15:45	9	0	0	0	9	0	0	0	0	0	0	0	0	9	0	0	0			
15:45 - 16:00	12	0	0	1	13	0	0	0	0	0	0	0	0	14	0	0	0			
16:00 - 16:15	12	0	0	0	12	1	0	0	0	0	0	0	0	12	1	0	0			
16:15 - 16:30	9	0	0	0	9	3	0	0	0	0	0	0	0	12	0	0	0			
16:30 - 16:45	6	0	2	0	8	0	2	0	0	0	0	0	0	10	0	0	0			
16:45 - 17:00	8	0	2	1	11	0	0	0	0	0	0	0	0	11	0	0	0			
17:00 - 17:15	11	0	0	0	11	0	0	0	0	0	0	0	0	11	0	0	0			
17:15 - 17:30	9	0	0	0	9	0	0	0	0	0	0	0	0	9	0	0	0			
17:30 - 17:45	16	1	1	1	18	1	0	0	0	0	0	0	0	18	0	0	0			
17:45 - 18:00	12	0	0	0	12	1	0	0	0	0	0	0	0	14	0	0	0			
TOTAL	461	1	26	15	4	507	12	32	0	10	5	0	47	1	0	0	0			
AM Peak	59	0	2	1	0	62	1	2	0	0	0	0	0	64	1	1	0			
PM Peak	48	0	1	1	0	50	0	1	0	1	0	0	0	52	0	0	0			

Movement	Oxley Hwy														Vehicles	Cycle	NB	SB		
	Est App - Straight				Est App - Right				Est App - U Turn				Est Total						Peds	
	Light	Bus	Rapid Heavy	Artic. Heavy	Light	Bus	Rapid Heavy	Artic. Heavy	Light	Bus	Rapid Heavy	Artic. Heavy	Total	Cyclist					Total	NB
06:00 - 06:15	8	0	0	0	8	0	0	0	0	0	0	0	0	13	0	0	0			
06:15 - 06:30	24	0	0	0	24	0	0	0	0	0	0	0	0	29	0	0	0			
06:30 - 06:45	8	0	0	0	8	0	0	0	0	0	0	0	0	12	0	0	0			
06:45 - 07:00	12	0	1	0	13	1	0	0	0	0	0	0	0	23	1	0	0			
07:00 - 07:15	7	2	0	0	9	2	0	0	0	0	0	0	0	11	0	0	0			
07:15 - 07:30	11	0	1	0	12	0	5	0	0	0	0	0	0	17	1	0	0			
07:30 - 07:45	24	0	0	1	25	0	2	0	0	0	0	0	0	27	1	0	0			
07:45 - 08:00	18	0	1	0	19	0	7	0	1	2	0	0	0	29	0	0	0			
08:00 - 08:15	14	0	1	0	15	0	8	0	2	2	0	0	0	27	2	0	0			
08:15 - 08:30	33	0	0	2	35	14	1	0	0	0	0	0	0	50	0	0	0			
08:30 - 08:45	28	2	0	0	30	2	8	1	1	0	0	0	0	40	2	0	0			
08:45 - 09:00	32	1	2	1	36	1	4	1	0	0	0	0	0	41	2	0	0			
09:00 - 09:15	22	0	0	0	22	1	15	1	0	0	0	0	0	38	2	0	0			
09:15 - 09:30	23	0	0	2	25	1	10	0	1	0	0	0	0	37	1	0	0			
09:30 - 09:45	25	0	2	0	27	1	9	0	2	0	0	0	0	38	2	0	0			
09:45 - 10:00	22	0	0	0	22	0	9	0	0	0	0	0	0	31	0	0	0			
10:00 - 10:15	15	0	0	0	15	0	10	0	1	0	0	0	0	26	1	0	0			
10:15 - 10:30	21	0	4	1	26	1	7	0	1	0	0	0	0	34	2	0	0			
10:30 - 10:45	15	0	1	1	17	0	12	0	1	0	0	0	0	30	0	0	0			
10:45 - 11:00	19	0	1	2	22	0	7	0	2	0	0	0	0	32	3	0	0			
11:00 - 11:15	10	0	0	0	10	1	6	0	1	0	0	0	0	17	2	0	0			
11:15 - 11:30	22	0	2	1	25	0	5	0	0	0	0	0	0	30	0	0	0			
11:30 - 11:45	13	0	1	1	15	0	9	0	0	0	0	0	0	25	1	0	0			
11:45 - 12:00	12	0	0	1	13	0	7	0	1	0	0	0	0	21	0	0	0			
12:00 - 12:15	20	0	1	0	21	0	10	0	0	0	0	0	0	31	0	0	0			
12:15 - 12:30	24	0	0	1	25	0	6	0	0	0	0	0	0	31	0	0	0			
12:30 - 12:45	24	0	2	1	27	1	7	0	0	1	0	0	0	35	2	0	0			
12:45 - 13:00	20	0	1	0	21	0	7	0	1	1	0	0	0	30	1	0	0			
13:00 - 13:15	24	0	0	0	24	0	11	0	0	0	0	0	0	35	0	0	0			
13:15 - 13:30	26	0	2	0	28	1	4	0	1	0	0	0	0	34	1	0	0			
13:30 - 13:45	17	0	0	2	19	0	10	0	1	0	0	0	0	30	0	0	0			
13:45 - 14:00	44	1	1	1	47	0	10	0	1	0	0	0	0	58	1	0	0			
14:00 - 14:15	20	0	1	1	22	1	10	0	0	0	0	0	0	32	1	0	0			
14:15 - 14:30	15	0	2	0	17	0	12	0	1	0	0	0	0	31	0	0	0			
14:30 - 14:45	16	0	1	1	18	2	4	0	0	0	0	0	0	22	4	0	0			
14:45 - 15:00	18	0	3	0	21	0	14	0	0	0	0	0	0	35	0	0	0			
15:00 - 15:15	19	0	0	1	20	1	9	0	0	1	0	0	0	30	1	0	0			
15:15 - 15:30	18	0	0	0	18	0	9	0	0	0	0	0	0	27	0	0	0			
15:30 - 15:45	20	2	1	0	23	0	7	1	0	1	0	0	0	32	0	0	0			
15:45 - 16:00	18	0	1	0	19	2	10	0	0	0	0	0	0	29	3	0	0			
16:00 - 16:15	24	0	3	3	30	0	11	0	0	0	0	0	0	41	0	0	0			
16:15 - 16:30	25	0	2	1	28	0	10	0	0											

Oxley Hwy & Hargreaves Ln

		Hargreaves Ln																
Movement	Time	Sth App - Left				Sth App - Right				Sth App - U Turn				Sth Total		Peds		
		Light	Bus	Rapid Heavy	Artic. Heavy	Light	Bus	Rapid Heavy	Artic. Heavy	Light	Bus	Rapid Heavy	Artic. Heavy	MA Heavy	Total	Vehicles	Cycle	EB
06:00 - 06:15	4	0	0	0	0	0	0	0	0	0	0	0	0	0	4	1	0	0
06:15 - 06:30	3	0	1	1	0	0	0	0	0	0	0	0	0	0	5	0	0	0
06:30 - 06:45	3	0	0	1	0	4	0	2	0	1	0	0	0	0	6	0	0	0
06:45 - 07:00	6	0	0	0	0	6	2	0	0	0	0	0	0	0	6	2	0	0
07:00 - 07:15	1	0	0	0	0	1	0	0	0	0	0	0	0	0	1	0	0	0
07:15 - 07:30	6	0	0	0	0	6	1	0	0	0	0	0	0	0	6	1	0	0
07:30 - 07:45	1	0	0	1	0	2	1	0	0	0	0	0	0	0	2	1	0	0
07:45 - 08:00	6	0	1	1	0	8	0	1	0	0	0	0	0	0	9	0	0	0
08:00 - 08:15	7	0	1	2	0	10	2	0	0	0	0	0	0	0	10	2	0	0
08:15 - 08:30	12	0	1	1	0	14	1	0	0	0	0	0	0	0	15	0	0	0
08:30 - 08:45	5	1	1	1	0	7	2	2	2	0	0	0	0	0	13	0	0	0
08:45 - 09:00	5	1	1	0	0	6	2	1	0	0	0	0	0	0	7	2	0	0
09:00 - 09:15	5	1	1	0	0	7	1	0	0	0	0	0	0	0	8	0	0	0
09:15 - 09:30	10	0	0	1	0	11	0	1	0	0	0	0	0	0	12	0	0	0
09:30 - 09:45	5	0	1	0	0	6	2	2	0	0	0	0	0	0	8	2	0	0
09:45 - 10:00	8	0	0	0	0	8	0	0	0	0	0	0	0	0	8	0	0	0
10:00 - 10:15	4	0	1	0	0	5	1	2	0	0	0	0	0	0	7	1	0	0
10:15 - 10:30	6	0	2	0	0	8	1	4	0	0	0	0	0	0	12	1	0	0
10:30 - 10:45	9	0	0	1	0	10	3	0	0	0	0	0	0	0	13	0	0	0
10:45 - 11:00	8	0	2	1	0	11	3	0	0	0	0	0	0	0	11	3	0	0
11:00 - 11:15	2	0	1	0	0	3	1	1	0	0	0	0	0	0	4	1	0	0
11:15 - 11:30	5	0	2	0	0	7	0	0	0	0	0	0	0	0	7	0	0	0
11:30 - 11:45	6	0	0	1	0	7	1	0	0	0	0	0	0	0	7	1	0	0
11:45 - 12:00	3	0	0	1	0	4	0	2	0	0	0	0	0	0	6	0	0	0
12:00 - 12:15	8	0	0	0	0	8	0	0	0	0	0	0	0	0	8	0	0	0
12:15 - 12:30	6	0	0	1	0	7	0	0	0	0	0	0	0	0	7	0	0	0
12:30 - 12:45	8	0	0	2	0	10	3	2	0	0	0	0	0	0	12	3	0	0
12:45 - 13:00	3	0	0	0	0	3	0	0	0	0	0	0	0	0	3	0	0	0
13:00 - 13:15	5	0	0	0	0	5	0	2	0	0	0	0	0	0	7	0	0	0
13:15 - 13:30	4	0	2	0	0	6	0	1	0	0	0	0	0	0	7	0	0	0
13:30 - 13:45	5	0	0	1	0	6	0	1	0	0	0	0	0	0	7	0	0	0
13:45 - 14:00	8	0	0	0	0	8	1	1	0	0	0	0	0	0	9	1	0	0
14:00 - 14:15	6	1	0	0	0	7	1	2	0	0	0	0	0	0	9	1	0	0
14:15 - 14:30	12	0	0	0	0	12	0	2	0	0	0	0	0	0	14	0	0	0
14:30 - 14:45	4	0	1	1	0	6	1	1	0	0	0	0	0	0	7	1	0	0
14:45 - 15:00	7	0	0	0	0	7	0	0	0	0	0	0	0	0	7	0	0	0
15:00 - 15:15	5	0	0	0	0	5	1	1	0	1	0	0	0	0	7	1	0	0
15:15 - 15:30	6	0	0	0	0	6	0	2	0	0	0	0	0	0	8	0	0	0
15:30 - 15:45	8	0	0	1	0	9	0	2	0	0	0	0	0	0	11	0	0	0
15:45 - 16:00	7	0	0	0	0	7	2	1	0	0	0	0	0	0	8	2	0	0
16:00 - 16:15	5	0	1	2	0	8	0	2	0	0	0	0	0	0	10	0	1	0
16:15 - 16:30	5	0	1	1	0	7	0	3	0	0	0	0	0	0	10	0	0	0
16:30 - 16:45	5	0	2	1	0	8	2	1	0	0	0	0	0	0	9	2	0	0
16:45 - 17:00	10	0	0	0	0	10	1	4	0	0	0	0	0	0	14	1	0	0
17:00 - 17:15	12	0	0	0	0	12	0	1	0	0	0	0	0	0	13	0	0	0
17:15 - 17:30	20	0	1	0	0	21	2	0	0	0	0	0	0	0	23	0	0	0
17:30 - 17:45	11	0	0	0	0	11	2	0	0	0	0	0	0	0	14	0	0	0
17:45 - 18:00	11	0	0	0	0	11	0	2	1	0	0	0	0	0	14	0	0	0
TOTAL	311	2	23	24	0	360	30	56	1	4	2	63	1	0	424	31	1	0
AM Peak	27	1	3	3	0	34	2	5	0	2	0	2	9	0	43	2	0	0
PM Peak	53	0	1	0	0	54	1	9	0	0	0	0	0	0	64	1	0	0

		Oxley Hwy																
Movement	Time	Est App - Left				Est App - Straight				Est App - U Turn				Est Total		Peds		
		Light	Bus	Rapid Heavy	Artic. Heavy	Light	Bus	Rapid Heavy	Artic. Heavy	Light	Bus	Rapid Heavy	Artic. Heavy	MA Heavy	Total	Vehicles	Cycle	NB
06:00 - 06:15	1	0	0	0	0	0	0	0	0	0	0	0	0	0	1	1	0	0
06:15 - 06:30	0	0	0	0	0	0	0	0	0	0	0	0	0	0	0	24	0	0
06:30 - 06:45	2	0	0	0	0	2	0	5	0	1	0	0	0	0	7	0	0	0
06:45 - 07:00	3	0	0	0	0	3	0	16	0	1	0	0	0	0	17	0	0	0
07:00 - 07:15	1	0	0	0	0	1	0	8	2	0	0	0	0	0	10	0	0	0
07:15 - 07:30	2	0	0	0	0	2	0	11	0	0	0	0	0	0	11	0	0	0
07:30 - 07:45	3	0	0	0	0	3	0	25	0	0	1	0	0	0	26	0	0	0
07:45 - 08:00	2	0	0	0	0	2	0	21	0	0	0	0	0	0	21	0	0	0
08:00 - 08:15	3	0	0	0	0	3	0	19	0	1	0	0	0	0	20	0	0	0
08:15 - 08:30	4	0	0	1	0	5	1	36	0	1	0	0	0	0	37	0	0	0
08:30 - 08:45	3	0	0	0	0	3	0	30	2	0	0	0	0	0	32	2	0	0
08:45 - 09:00	2	0	0	0	0	2	0	33	1	2	1	0	0	0	37	0	0	0
09:00 - 09:15	2	0	0	1	0	3	0	32	0	1	0	0	0	0	33	1	0	0
09:15 - 09:30	1	0	0	0	0	1	0	24	0	0	0	1	25	2	0	0	0	0
09:30 - 09:45	2	0	0	0	0	2	0	30	0	3	0	0	0	0	33	0	0	0
09:45 - 10:00	0	0	0	0	0	0	0	22	0	1	0	0	0	0	23	0	0	0
10:00 - 10:15	1	0	0	0	0	1	0	23	0	0	0	0	0	0	23	0	0	0
10:15 - 10:30	4	0	0	0	0	4	0	21	0	3	1	0	0	0	25	1	0	0
10:30 - 10:45	3	0	0	0	0	3	0	19	0	3	0	0	0	0	22	0	0	0
10:45 - 11:00	0	0	0	0	0	0	0	19	0	0	1	0	0	0	20	0	0	0
11:00 - 11:15	4	0	0	1	0	5	0	14	0	0	0	0	0	0	14	1	0	0
11:15 - 11:30	0	0	0	0	0	0	0	21	0	0	1	0	0	0	22	0	0	0
11:30 - 11:45	2	0	0	0	0	2	0	18	0	1	1	0	0	0	20	0	0	0
11:45 - 12:00	2	0	0	0	0	2	0	16	0	0	0	0	0	0	16	0	0	0
12:00 - 12:15	1	0	0	0	0	1	0	19	0	1	0	0	0	0	20	0	0	0
12:15 - 12:30	2	0	0	0	0	2	0	24	0	0	0	0	0	0	24	0	0	0
12:30 - 12:45	1	0	0	1	0	2	0	25	0	1	1	0	0	0	27	0	0	0
12:45 - 13:00	3	0	0	1	0	4	0	29	0	2	0	0	0	0	31	0	0	0
13:00 - 13:15	1	0	0	0	0	1	0	25	0	1	0	0	0	0	26	0	0	0
13:15 - 13:30	2	0	0	0	0	2	0	28	0	0	1	0	0	0	29	0	0	0
13:30 - 13:45	3	0	0	0	0	3	0	23	0	1	0	0	0	0	24	0	0	0
13:45 - 14:00	1	0	0	0	0	1	0	50	0	1	0	0	0	0	51	0	0	0
14:00 - 14:15	0	0	0	0	0	0	0	21	0	1	1	0	0	0	23	0	0	0
14:15 - 14:30	4	0	0	0	0	4	0	17	0	3	0	1	21	1	0	0	0	0
14:30 - 14:45	0	0	1	0	0	1	0	19	0	0	0	0	0	0	19	2	0	0
14:45 - 15:00	3	0	0	0	0	3	0	26	0	3	0	0	0	0	29	0	0	0
15:00 - 15:15	2	0	0	0	0	2	0	23	0	0	1	0	0	0	24	1	0	0
15:15 - 15:30	3	0	1	0	0	4	0	21	0	0	0							

Castlereagh Hwy & Federation St

Table with columns: Movement, Time, Sth App - Left, Sth App - Right, Sth App - U Turn, Sth Total, Peds. Rows include time intervals from 06:00-06:15 to 16:00-16:15, and summary rows for AM Peak, PM Peak, and Total.

Table with columns: Movement, Time, Est App - Left, Est App - Straight, Est App - U Turn, Est Total, Peds. Rows include time intervals from 06:00-06:15 to 16:00-16:15, and summary rows for AM Peak, PM Peak, and Total.

Table with columns: Movement, Time, Wst App - Straight, Wst App - Right, Wst App - U Turn, Wst Total, Peds. Rows include time intervals from 06:00-06:15 to 16:00-16:15, and summary rows for AM Peak, PM Peak, and Total.

Newell Hwy & Hargraves Ln

Movement	Newell Hwy														Vehicles	Cycle	EB	WB			
	Nth App - Straight				Nth App - Right				Nth App - U Turn				Nth Total						Peds		
	Light	Bus	Rapid Heavy	Artic. Heavy	M/A Heavy	Total	Cyclist	Light	Bus	Rapid Heavy	Artic. Heavy	M/A Heavy	Total	Cyclist					Light	Bus	Rapid Heavy
06:00 - 06:15	6	0	0	0	0	6	1	0	0	0	0	0	0	0	7	1	0	0	0	0	0
06:15 - 06:30	5	0	0	0	0	5	1	0	0	0	0	0	0	0	6	1	0	0	0	0	0
06:30 - 06:45	13	0	1	1	0	15	1	0	0	0	0	0	0	0	16	2	0	0	0	0	0
06:45 - 07:00	12	2	2	3	0	19	0	1	0	0	0	0	0	0	20	0	0	0	0	0	0
07:00 - 07:15	23	1	1	1	0	26	0	0	0	0	0	0	0	0	26	0	0	0	0	0	0
07:15 - 07:30	14	0	0	2	0	16	0	0	0	0	0	0	0	0	16	0	0	0	0	0	0
07:30 - 07:45	17	1	0	4	0	22	4	0	0	0	0	0	0	0	22	4	0	0	0	0	0
07:45 - 08:00	17	0	1	1	0	19	4	1	0	0	0	0	0	0	20	4	0	0	0	0	0
08:00 - 08:15	26	0	2	2	0	30	0	1	0	0	0	0	0	0	31	1	0	0	0	0	0
08:15 - 08:30	26	1	1	1	0	29	3	3	0	0	0	0	0	0	34	3	0	0	0	0	0
08:30 - 08:45	24	0	3	0	0	27	1	1	0	0	0	0	0	0	29	1	0	0	0	0	0
08:45 - 09:00	22	0	2	1	0	25	4	4	0	0	0	0	0	0	29	4	0	0	0	0	0
09:00 - 09:15	30	1	1	0	0	32	2	2	0	0	0	0	0	0	34	2	0	0	0	0	0
09:15 - 09:30	18	0	0	2	0	20	5	1	0	0	0	0	0	0	21	5	0	0	0	0	0
09:30 - 09:45	31	1	1	1	0	34	5	3	0	0	0	0	0	0	37	6	0	0	0	0	0
09:45 - 10:00	27	0	1	1	0	29	3	2	0	0	0	0	0	0	31	3	0	0	0	0	0
10:00 - 10:15	22	0	1	2	0	25	2	3	0	0	0	0	0	0	29	2	0	0	0	0	0
10:15 - 10:30	23	0	3	1	0	27	0	2	0	0	0	0	0	0	29	0	0	0	0	0	0
10:30 - 10:45	24	1	1	1	0	27	3	0	0	0	0	0	0	0	27	3	0	0	0	0	0
10:45 - 11:00	23	0	2	5	0	30	2	1	0	0	0	0	0	0	31	2	0	0	0	0	0
11:00 - 11:15	29	0	0	5	0	34	1	1	0	0	0	0	0	0	36	1	0	0	0	0	0
11:15 - 11:30	20	0	1	5	0	26	5	0	0	0	0	0	0	0	26	5	0	0	0	0	0
11:30 - 11:45	26	0	1	0	0	27	3	0	0	0	0	0	0	0	27	3	0	0	0	0	0
11:45 - 12:00	26	0	2	2	0	30	2	2	0	0	0	0	0	0	32	2	0	0	0	0	0
12:00 - 12:15	24	1	0	1	0	26	1	1	0	0	0	0	0	0	27	1	0	0	0	0	0
12:15 - 12:30	19	0	1	0	0	20	1	1	0	0	0	0	0	0	21	1	0	0	0	0	0
12:30 - 12:45	22	0	1	1	0	24	2	0	0	0	0	0	0	0	24	4	0	0	0	0	0
12:45 - 13:00	28	0	2	5	0	35	3	0	0	0	0	0	0	0	35	3	0	0	0	0	0
13:00 - 13:15	27	0	2	0	0	29	1	0	0	0	0	0	0	0	29	1	0	0	0	0	0
13:15 - 13:30	18	0	1	4	0	23	4	1	0	0	0	0	0	0	24	4	0	0	0	0	0
13:30 - 13:45	21	0	2	2	0	25	1	1	0	0	0	0	0	0	26	1	0	0	0	0	0
13:45 - 14:00	13	0	2	0	0	15	3	0	0	0	0	0	0	0	16	4	0	0	0	0	0
14:00 - 14:15	30	0	4	4	0	38	6	4	0	0	0	0	0	0	42	6	0	0	0	0	0
14:15 - 14:30	28	0	2	2	0	32	1	0	0	0	0	0	0	0	32	1	0	0	0	0	0
14:30 - 14:45	21	0	1	3	0	25	3	1	0	0	0	0	0	0	26	3	0	0	0	0	0
14:45 - 15:00	33	0	1	4	0	38	0	0	0	0	0	0	0	0	39	0	0	0	0	0	0
15:00 - 15:15	18	0	0	7	0	25	2	1	0	0	0	0	0	0	26	2	0	0	0	0	0
15:15 - 15:30	23	0	0	1	0	24	5	0	0	0	0	0	0	0	24	5	0	0	0	0	0
15:30 - 15:45	37	1	2	1	0	41	5	0	0	0	0	0	0	0	41	5	0	0	0	0	0
15:45 - 16:00	29	1	1	3	0	34	1	2	0	0	0	0	0	0	36	2	0	0	0	0	0
16:00 - 16:15	25	0	1	2	0	28	2	0	0	0	0	0	0	0	28	2	0	0	0	0	0
16:15 - 16:30	21	0	4	1	1	27	2	2	0	0	0	0	0	0	29	2	0	0	0	0	0
16:30 - 16:45	23	0	5	0	0	28	1	2	0	0	0	0	0	0	30	1	0	0	0	0	0
16:45 - 17:00	8	1	0	3	0	12	1	2	0	0	0	0	0	0	14	1	0	0	0	0	0
17:00 - 17:15	14	0	2	2	0	18	5	1	0	0	0	0	0	0	19	5	0	0	0	0	0
17:15 - 17:30	18	0	1	0	0	19	2	2	0	0	0	0	0	0	21	2	0	0	0	0	0
17:30 - 17:45	15	0	1	1	0	17	2	0	0	0	0	0	0	0	17	2	0	0	0	0	0
17:45 - 18:00	12	0	1	3	0	16	5	0	0	0	0	0	0	0	17	5	0	0	0	0	0
TOTAL	1034	11	64	92	1	1202	112	50	1	2	2	57	7	2	1261	119	0	0	0	0	0
AM Peak	102	1	7	3	0	113	10	10	1	0	0	2	13	0	126	10	0	0	0	0	0
PM Peak	112	2	8	7	1	130	10	4	0	0	0	0	0	0	134	11	0	0	0	0	0

Movement	Newell Hwy														Vehicles	Cycle	EB	WB			
	Sth App - Left				Sth App - Straight				Sth App - U Turn				Sth Total						Peds		
	Light	Bus	Rapid Heavy	Artic. Heavy	M/A Heavy	Total	Cyclist	Light	Bus	Rapid Heavy	Artic. Heavy	M/A Heavy	Total	Cyclist					Light	Bus	Rapid Heavy
06:00 - 06:15	4	0	0	1	0	5	0	0	0	0	0	0	0	0	5	0	0	0	0	0	0
06:15 - 06:30	2	0	0	1	0	3	0	0	0	0	0	0	0	0	3	0	0	0	0	0	0
06:30 - 06:45	2	0	1	1	0	4	0	0	0	0	0	0	0	0	4	0	0	0	0	0	0
06:45 - 07:00	5	0	0	0	0	5	1	1	0	0	0	0	0	0	7	1	0	0	0	0	0
07:00 - 07:15	1	0	0	1	0	2	0	0	0	0	0	0	0	0	2	0	0	0	0	0	0
07:15 - 07:30	6	0	0	0	0	6	1	2	0	0	0	0	0	0	8	3	0	0	0	0	0
07:30 - 07:45	3	0	0	1	0	4	1	2	0	0	0	0	0	0	6	3	0	0	0	0	0
07:45 - 08:00	8	0	2	3	0	13	0	2	0	0	0	0	0	0	15	2	0	0	0	0	0
08:00 - 08:15	4	0	2	0	0	6	1	1	0	0	0	0	0	0	7	2	0	0	0	0	0
08:15 - 08:30	10	0	1	1	0	11	0	1	0	0	0	0	0	0	12	1	0	0	0	0	0
08:30 - 08:45	3	0	1	1	0	5	0	1	0	0	0	0	0	0	6	1	0	0	0	0	0
08:45 - 09:00	4	0	1	1	0	6	2	2	0	0	0	0	0	0	8	2	0	0	0	0	0
09:00 - 09:15	5	0	1	1	0	7	0	1	0	0	0	0	0	0	8	1	0	0	0	0	0
09:15 - 09:30	9	0	1	1	0	11	0	1	0	0	0	0	0	0	12	1	0	0	0	0	0
09:30 - 09:45	2	0	0	0	0	2	1	2	0	0	0	0	0	0	4	2	0	0	0	0	0
09:45 - 10:00	9	0	1	0	0	10	0	2	0	0	0	0	0	0	12	0	0	0	0	0	0
10:00 - 10:15	6	0	1	0	0	7	1	2	0	0	0	0	0	0	9	2	0	0	0	0	0
10:15 - 10:30	8	0	0	0	0	8	1	2	0	0	0	0	0	0	10	2	0	0	0	0	0
10:30 - 10:45	8	0	0	1	0	9	0	2	0	0	0	0	0	0	11	0	0	0	0	0	0
10:45 - 11:00	6	0	3	3	0	12	3	2	0	0	0	0	0	0	15	3	0	0	0	0	0
11:00 - 11:15	2	0	1	0	0	3	1	1	0	0	0	0	0	0	4	1	0	0	0	0	0
11:15 - 11:30	5	0	1	0	0	6	0	1	0	0	0	0	0	0	7	0	0	0	0	0	0
11:30 - 11:45	5	0	2	0	0	7	1	3	0	0	0	0	0	0	10	3	0	0	0	0	0
11:45 - 12:00	2	0	1	0	0	3	0	1	0	0	0	0	0	0	4	0	0	0	0	0	0
12:00 - 12:15	7	0	1	0	0	8	0	2	0	0	0	0	0	0	10	2	0	0	0	0	0
12:15 - 12:30	8	0	0	1	0	9	0	3	0	0	0	0	0	0	12	0	0	0	0	0	0
12:30 - 12:45	7	0	0	1	0	8	2	1	0												

Appendix C

SIDRA Results



SITE LAYOUT

▽ Site: 101 [Oxley Highway and Site Access - Project AM (Site Folder: Project Case)]

New Site
Site Category: (None)
Give-Way (Two-Way)

Layout pictures are schematic functional drawings reflecting input data. They are not design drawings.

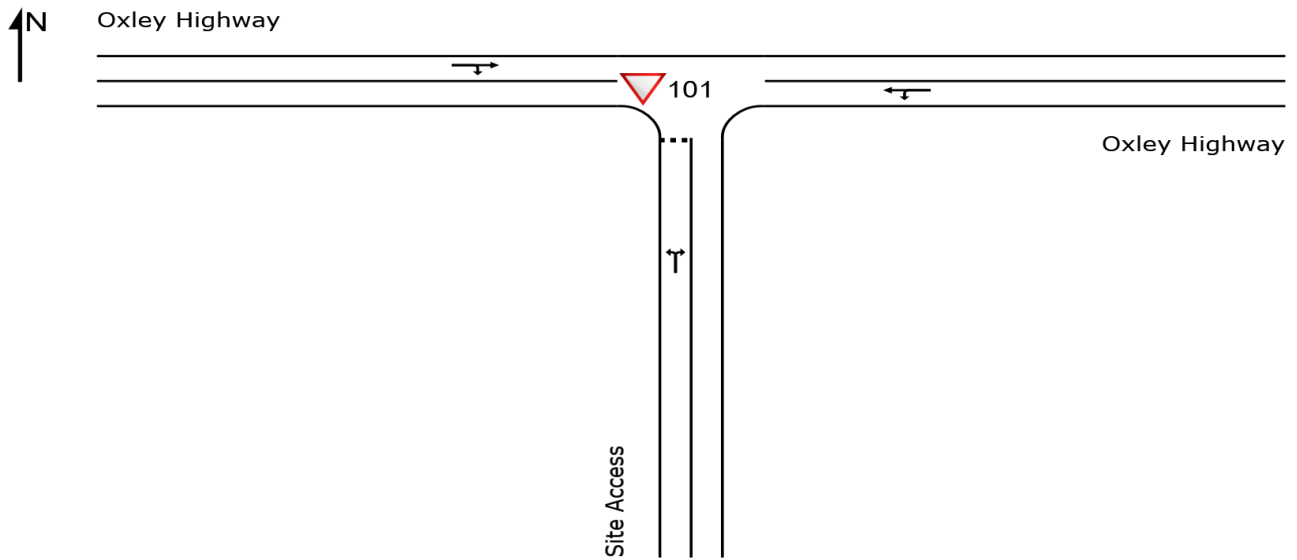

MOVEMENT SUMMARY

Site: 101 [Oxley Highway and Site Access - Project AM (Site Folder: Project Case)]

Output produced by SIDRA INTERSECTION Version: 9.1.1.200

New Site
 Site Category: (None)
 Give-Way (Two-Way)

Vehicle Movement Performance															
Mov ID	Turn	Mov Class	Demand Flows		Arrival Flows		Deg. Satn	Aver. Delay	Level of Service	95% Back Of Queue		Prop. Que	Eff. Stop Rate	Aver. No. of Cycles	Aver. Speed
			[Total HV]	%	[Total HV]	%	v/c	sec		[Veh. veh	Dist] m				km/h
South: Site Access															
1	L2	All MCs	1	0.0	1	0.0	0.004	5.6	LOS A	0.0	0.1	0.12	0.56	0.12	52.6
3	R2	All MCs	4	0.0	4	0.0	0.004	5.7	LOS A	0.0	0.1	0.12	0.56	0.12	52.3
Approach			5	0.0	5	0.0	0.004	5.7	LOS A	0.0	0.1	0.12	0.56	0.12	52.4
East: Oxley Highway															
4	L2	All MCs	7	14.3	7	14.3	0.017	5.7	LOS A	0.0	0.0	0.00	0.15	0.00	55.5
5	T1	All MCs	22	23.8	22	23.8	0.017	0.0	LOS A	0.0	0.0	0.00	0.15	0.00	58.5
Approach			29	21.4	29	21.4	0.017	1.4	NA	0.0	0.0	0.00	0.15	0.00	57.7
West: Oxley Highway															
11	T1	All MCs	44	16.7	44	16.7	0.026	0.0	LOS A	0.0	0.0	0.01	0.01	0.01	59.8
12	R2	All MCs	1	0.0	1	0.0	0.026	5.5	LOS A	0.0	0.0	0.01	0.01	0.01	57.0
Approach			45	16.3	45	16.3	0.026	0.1	NA	0.0	0.0	0.01	0.01	0.01	59.8
All Vehicles			80	17.1	80	17.1	0.026	1.0	NA	0.0	0.1	0.01	0.10	0.01	58.5

Site Level of Service (LOS) Method: Delay (RTA NSW). Site LOS Method is specified in the Parameter Settings dialog (Options tab).

Vehicle movement LOS values are based on average delay per movement.

Minor Road Approach LOS values are based on average delay for all vehicle movements.

NA (TWSC): Level of Service is not defined for major road approaches or the intersection as a whole for Two-Way Sign Control (HCM LOS rule).

Two-Way Sign Control Capacity Model: SIDRA Standard.

Delay Model: SIDRA Standard (Control Delay: Geometric Delay is included).

Queue Model: SIDRA queue estimation methods are used for Back of Queue and Queue at Start of Gap.

Gap-Acceptance Capacity Formula: SIDRA Standard (Akçelik M3D).

HV (%) values are calculated for All Movement Classes of All Heavy Vehicle Model Designation.

Arrival Flows used in performance calculations are adjusted to include any Initial Queued Demand and Upstream Capacity Constraint effects.

SIDRA INTERSECTION 9.1 | Copyright © 2000-2022 Akcelik and Associates Pty Ltd | sidrasolutions.com

Organisation: AMBER ORGANISATION | Licence: NETWORK / 1PC | Processed: Tuesday, 26 March 2024 4:10:22 PM

Project: C:\Users\olive\OneDrive - Amber Organisation Pty Ltd\Amber\Jobs\814 - Gilgandra Industrial Subdivision\Modelling\814 Gilgandra 240326.sip9

MOVEMENT SUMMARY

Site: 101 [Oxley Highway and Site Access - Project PM (Site Folder: Project Case)]

Output produced by SIDRA INTERSECTION Version: 9.1.1.200

New Site
 Site Category: (None)
 Give-Way (Two-Way)

Vehicle Movement Performance															
Mov ID	Turn	Mov Class	Demand Flows		Arrival Flows		Deg. Satn	Aver. Delay	Level of Service	95% Back Of Queue		Prop. Que	Eff. Stop Rate	Aver. No. of Cycles	Aver. Speed
			[Total HV]	%	[Total HV]	%	v/c	sec		[Veh. veh	Dist] m				km/h
South: Site Access															
1	L2	All MCs	1	0.0	1	0.0	0.007	5.6	LOSA	0.0	0.2	0.13	0.56	0.13	52.6
3	R2	All MCs	7	14.3	7	14.3	0.007	5.8	LOSA	0.0	0.2	0.13	0.56	0.13	51.7
Approach			8	12.5	8	12.5	0.007	5.8	LOSA	0.0	0.2	0.13	0.56	0.13	51.8
East: Oxley Highway															
4	L2	All MCs	3	0.0	3	0.0	0.019	5.5	LOSA	0.0	0.0	0.00	0.05	0.00	57.0
5	T1	All MCs	32	10.0	32	10.0	0.019	0.0	LOSA	0.0	0.0	0.00	0.05	0.00	59.4
Approach			35	9.1	35	9.1	0.019	0.5	NA	0.0	0.0	0.00	0.05	0.00	59.2
West: Oxley Highway															
11	T1	All MCs	25	33.3	25	33.3	0.016	0.0	LOSA	0.0	0.1	0.01	0.02	0.01	59.6
12	R2	All MCs	1	0.0	1	0.0	0.016	5.5	LOSA	0.0	0.1	0.01	0.02	0.01	56.8
Approach			26	32.0	26	32.0	0.016	0.2	NA	0.0	0.1	0.01	0.02	0.01	59.5
All Vehicles			69	18.2	69	18.2	0.019	1.0	NA	0.0	0.2	0.02	0.10	0.02	58.3

Site Level of Service (LOS) Method: Delay (RTA NSW). Site LOS Method is specified in the Parameter Settings dialog (Options tab).

Vehicle movement LOS values are based on average delay per movement.

Minor Road Approach LOS values are based on average delay for all vehicle movements.

NA (TWSC): Level of Service is not defined for major road approaches or the intersection as a whole for Two-Way Sign Control (HCM LOS rule).

Two-Way Sign Control Capacity Model: SIDRA Standard.

Delay Model: SIDRA Standard (Control Delay: Geometric Delay is included).

Queue Model: SIDRA queue estimation methods are used for Back of Queue and Queue at Start of Gap.

Gap-Acceptance Capacity Formula: SIDRA Standard (Akçelik M3D).

HV (%) values are calculated for All Movement Classes of All Heavy Vehicle Model Designation.

Arrival Flows used in performance calculations are adjusted to include any Initial Queued Demand and Upstream Capacity Constraint effects.

SIDRA INTERSECTION 9.1 | Copyright © 2000-2022 Akcelik and Associates Pty Ltd | sidrasolutions.com

Organisation: AMBER ORGANISATION | Licence: NETWORK / 1PC | Processed: Tuesday, 26 March 2024 4:11:45 PM

Project: C:\Users\olive\OneDrive - Amber Organisation Pty Ltd\Amber\Jobs\814 - Gilgandra Industrial Subdivision\Modelling\814 Gilgandra 240326.sip9

MOVEMENT SUMMARY

Site: 101 [Oxley Highway and Site Access - Future AM (Site Folder: 20-year Future Scenario)]

Output produced by SIDRA INTERSECTION Version: 9.1.1.200

New Site
 Site Category: (None)
 Give-Way (Two-Way)

Vehicle Movement Performance															
Mov ID	Turn	Mov Class	Demand Flows		Arrival Flows		Deg. Satn	Aver. Delay	Level of Service	95% Back Of Queue		Prop. Que	Eff. Stop Rate	Aver. No. of Cycles	Aver. Speed
			[Total HV]	%	[Total HV]	%	v/c	sec		[Veh.]	[Dist]				km/h
			veh/h		veh/h					veh	m				
South: Site Access															
1	L2	All MCs	1	0.0	1	0.0	0.004	5.6	LOSA	0.0	0.1	0.14	0.55	0.14	52.5
3	R2	All MCs	4	0.0	4	0.0	0.004	5.8	LOSA	0.0	0.1	0.14	0.55	0.14	52.3
Approach			5	0.0	5	0.0	0.004	5.7	LOSA	0.0	0.1	0.14	0.55	0.14	52.3
East: Oxley Highway															
4	L2	All MCs	7	14.3	7	14.3	0.022	5.7	LOSA	0.0	0.0	0.00	0.11	0.00	55.8
5	T1	All MCs	31	24.1	31	24.1	0.022	0.0	LOSA	0.0	0.0	0.00	0.11	0.00	58.8
Approach			38	22.2	38	22.2	0.022	1.1	NA	0.0	0.0	0.00	0.11	0.00	58.2
West: Oxley Highway															
11	T1	All MCs	59	16.1	59	16.1	0.034	0.0	LOSA	0.0	0.0	0.00	0.01	0.00	59.9
12	R2	All MCs	1	0.0	1	0.0	0.034	5.5	LOSA	0.0	0.0	0.00	0.01	0.00	57.0
Approach			60	15.8	60	15.8	0.034	0.1	NA	0.0	0.0	0.00	0.01	0.00	59.8
All Vehicles			103	17.3	103	17.3	0.034	0.8	NA	0.0	0.1	0.01	0.08	0.01	58.8

Site Level of Service (LOS) Method: Delay (RTA NSW). Site LOS Method is specified in the Parameter Settings dialog (Options tab).

Vehicle movement LOS values are based on average delay per movement.

Minor Road Approach LOS values are based on average delay for all vehicle movements.

NA (TWSC): Level of Service is not defined for major road approaches or the intersection as a whole for Two-Way Sign Control (HCM LOS rule).

Two-Way Sign Control Capacity Model: SIDRA Standard.

Delay Model: SIDRA Standard (Control Delay: Geometric Delay is included).

Queue Model: SIDRA queue estimation methods are used for Back of Queue and Queue at Start of Gap.

Gap-Acceptance Capacity Formula: SIDRA Standard (Akçelik M3D).

HV (%) values are calculated for All Movement Classes of All Heavy Vehicle Model Designation.

Arrival Flows used in performance calculations are adjusted to include any Initial Queued Demand and Upstream Capacity Constraint effects.

SIDRA INTERSECTION 9.1 | Copyright © 2000-2022 Akcelik and Associates Pty Ltd | sidrasolutions.com

Organisation: AMBER ORGANISATION | Licence: NETWORK / 1PC | Processed: Tuesday, 26 March 2024 4:12:37 PM

Project: C:\Users\olive\OneDrive - Amber Organisation Pty Ltd\Amber\Jobs\814 - Gilgandra Industrial Subdivision\Modelling\814 Gilgandra 240326.sip9

MOVEMENT SUMMARY

Site: 101 [Oxley Highway and Site Access - Future PM (Site Folder: 20-year Future Scenario)]

Output produced by SIDRA INTERSECTION Version: 9.1.1.200

New Site
 Site Category: (None)
 Give-Way (Two-Way)

Vehicle Movement Performance															
Mov ID	Turn	Mov Class	Demand Flows		Arrival Flows		Deg. Satn	Aver. Delay	Level of Service	95% Back Of Queue		Prop. Que	Eff. Stop Rate	Aver. No. of Cycles	Aver. Speed
			[Total HV]	%	[Total HV]	%	v/c	sec		[Veh.]	[Dist]				km/h
			veh/h		veh/h					veh	m				
South: Site Access															
1	L2	All MCs	1	0.0	1	0.0	0.007	5.7	LOS A	0.0	0.2	0.15	0.56	0.15	52.5
3	R2	All MCs	7	14.3	7	14.3	0.007	5.9	LOS A	0.0	0.2	0.15	0.56	0.15	51.6
Approach			8	12.5	8	12.5	0.007	5.9	LOS A	0.0	0.2	0.15	0.56	0.15	51.7
East: Oxley Highway															
4	L2	All MCs	3	0.0	3	0.0	0.025	5.5	LOS A	0.0	0.0	0.00	0.04	0.00	57.1
5	T1	All MCs	42	10.0	42	10.0	0.025	0.0	LOS A	0.0	0.0	0.00	0.04	0.00	59.6
Approach			45	9.3	45	9.3	0.025	0.4	NA	0.0	0.0	0.00	0.04	0.00	59.4
West: Oxley Highway															
11	T1	All MCs	35	33.3	35	33.3	0.022	0.0	LOS A	0.0	0.1	0.01	0.02	0.01	59.7
12	R2	All MCs	1	0.0	1	0.0	0.022	5.5	LOS A	0.0	0.1	0.01	0.02	0.01	56.9
Approach			36	32.4	36	32.4	0.022	0.2	NA	0.0	0.1	0.01	0.02	0.01	59.6
All Vehicles			89	18.8	89	18.8	0.025	0.8	NA	0.0	0.2	0.02	0.08	0.02	58.7

Site Level of Service (LOS) Method: Delay (RTA NSW). Site LOS Method is specified in the Parameter Settings dialog (Options tab).

Vehicle movement LOS values are based on average delay per movement.

Minor Road Approach LOS values are based on average delay for all vehicle movements.

NA (TWSC): Level of Service is not defined for major road approaches or the intersection as a whole for Two-Way Sign Control (HCM LOS rule).

Two-Way Sign Control Capacity Model: SIDRA Standard.

Delay Model: SIDRA Standard (Control Delay: Geometric Delay is included).

Queue Model: SIDRA queue estimation methods are used for Back of Queue and Queue at Start of Gap.

Gap-Acceptance Capacity Formula: SIDRA Standard (Akçelik M3D).

HV (%) values are calculated for All Movement Classes of All Heavy Vehicle Model Designation.

Arrival Flows used in performance calculations are adjusted to include any Initial Queued Demand and Upstream Capacity Constraint effects.

SIDRA INTERSECTION 9.1 | Copyright © 2000-2022 Akcelik and Associates Pty Ltd | sidrasolutions.com

Organisation: AMBER ORGANISATION | Licence: NETWORK / 1PC | Processed: Tuesday, 26 March 2024 4:13:22 PM

Project: C:\Users\olive\OneDrive - Amber Organisation Pty Ltd\Amber\Jobs\814 - Gilgandra Industrial Subdivision\Modelling\814 Gilgandra 240326.sip9

SITE LAYOUT

▽ Site: 101 [Oxley Highway and Federation Street Intersection - Project AM (Site Folder: Project Case)]

New Site
Site Category: (None)
Give-Way (Two-Way)

Layout pictures are schematic functional drawings reflecting input data. They are not design drawings.

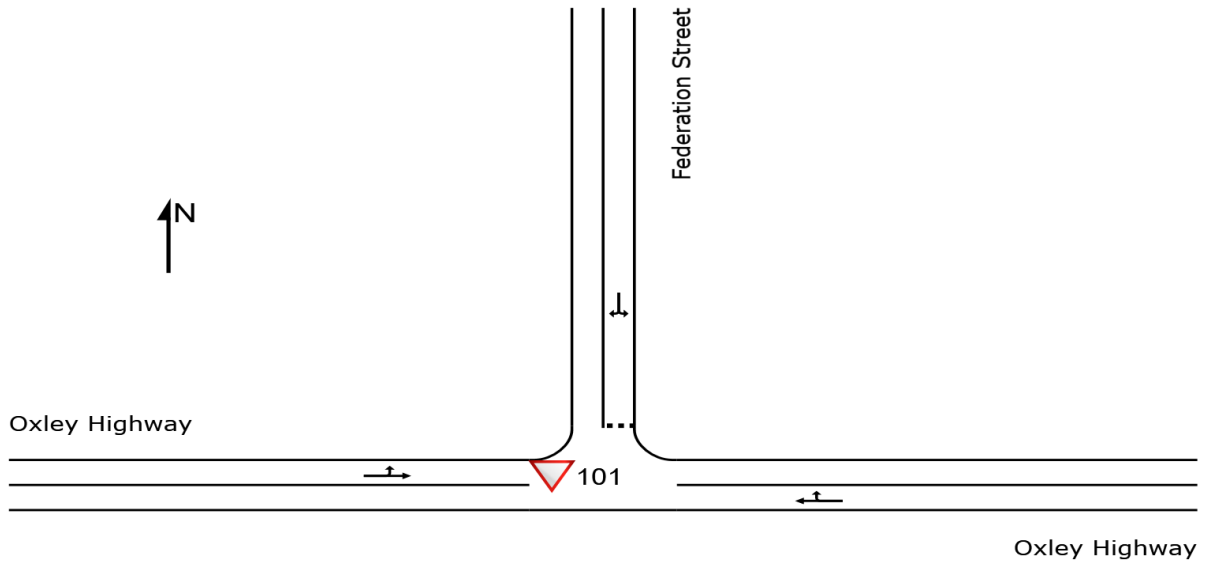

MOVEMENT SUMMARY

Site: 101 [Oxley Highway and Federation Street Intersection - Project AM (Site Folder: Project Case)]

Output produced by SIDRA INTERSECTION Version: 9.1.1.200

New Site
 Site Category: (None)
 Give-Way (Two-Way)

Vehicle Movement Performance															
Mov ID	Turn	Mov Class	Demand Flows		Arrival Flows		Deg. Satn	Aver. Delay	Level of Service	95% Back Of Queue		Prop. Que	Eff. Stop Rate	Aver. No. of Cycles	Aver. Speed
			[Total HV]	%	[Total HV]	%	v/c	sec		[Veh. veh	Dist] m				km/h
East: Oxley Highway															
5	T1	All MCs	136	7.0	136	7.0	0.108	0.0	LOSA	0.3	2.5	0.17	0.21	0.17	58.0
6	R2	All MCs	48	10.9	48	10.9	0.108	6.9	LOSA	0.3	2.5	0.17	0.21	0.17	50.9
Approach			184	8.0	184	8.0	0.108	1.8	NA	0.3	2.5	0.17	0.21	0.17	56.5
North: Federation Street															
7	L2	All MCs	65	4.8	65	4.8	0.049	5.1	LOSA	0.2	1.4	0.26	0.52	0.26	47.5
9	R2	All MCs	2	0.0	2	0.0	0.049	5.9	LOSA	0.2	1.4	0.26	0.52	0.26	47.4
Approach			67	4.7	67	4.7	0.049	5.1	LOSA	0.2	1.4	0.26	0.52	0.26	47.5
West: Oxley Highway															
10	L2	All MCs	100		100		0.085	6.7	LOSA	0.0	0.0	0.00	0.00	0.00	30.9
11	T1	All MCs	154	10.3	154	10.3	0.085	0.0	LOSA	0.0	0.0	0.00	0.00	0.00	59.9
Approach			155	10.9	155	10.9	0.085	0.1	NA	0.0	0.0	0.00	0.00	0.00	59.7
All Vehicles			406	8.5	406	8.5	0.108	1.7	NA	0.3	2.5	0.12	0.18	0.12	56.5

Site Level of Service (LOS) Method: Delay (RTA NSW). Site LOS Method is specified in the Parameter Settings dialog (Options tab).

Vehicle movement LOS values are based on average delay per movement.

Minor Road Approach LOS values are based on average delay for all vehicle movements.

NA (TWSC): Level of Service is not defined for major road approaches or the intersection as a whole for Two-Way Sign Control (HCM LOS rule).

Two-Way Sign Control Capacity Model: SIDRA Standard.

Delay Model: SIDRA Standard (Control Delay: Geometric Delay is included).

Queue Model: SIDRA queue estimation methods are used for Back of Queue and Queue at Start of Gap.

Gap-Acceptance Capacity Formula: SIDRA Standard (Akçelik M3D).

HV (%) values are calculated for All Movement Classes of All Heavy Vehicle Model Designation.

Arrival Flows used in performance calculations are adjusted to include any Initial Queued Demand and Upstream Capacity Constraint effects.

SIDRA INTERSECTION 9.1 | Copyright © 2000-2022 Akcelik and Associates Pty Ltd | sidrasolutions.com

Organisation: AMBER ORGANISATION | Licence: NETWORK / 1PC | Processed: Tuesday, 26 March 2024 4:14:52 PM

Project: C:\Users\olive\OneDrive - Amber Organisation Pty Ltd\Amber\Jobs\814 - Gilgandra Industrial Subdivision\Modelling\814 Gilgandra 240326.sip9

MOVEMENT SUMMARY

Site: 101 [Oxley Highway and Federation Street Intersection - Project PM (Site Folder: Project Case)]

Output produced by SIDRA INTERSECTION Version: 9.1.1.200

New Site
 Site Category: (None)
 Give-Way (Two-Way)

Vehicle Movement Performance															
Mov ID	Turn	Mov Class	Demand Flows		Arrival Flows		Deg. Satn	Aver. Delay	Level of Service	95% Back Of Queue		Prop. Que	Eff. Stop Rate	Aver. No. of Cycles	Aver. Speed
			[Total HV]	%	[Total HV]	%	v/c	sec		[Veh. veh	Dist] m				km/h
East: Oxley Highway															
5	T1	All MCs	108	5.8	108	5.8	0.099	0.0	LOSA	0.4	2.7	0.17	0.26	0.17	57.4
6	R2	All MCs	65	3.2	65	3.2	0.099	6.2	LOSA	0.4	2.7	0.17	0.26	0.17	50.9
Approach			174	4.8	174	4.8	0.099	2.3	NA	0.4	2.7	0.17	0.26	0.17	55.4
North: Federation Street															
7	L2	All MCs	53	4.0	53	4.0	0.039	4.9	LOSA	0.2	1.1	0.21	0.51	0.21	47.7
9	R2	All MCs	250.0		250.0		0.039	6.9	LOSA	0.2	1.1	0.21	0.51	0.21	45.0
Approach			55	5.8	55	5.8	0.039	5.0	LOSA	0.2	1.1	0.21	0.51	0.21	47.6
West: Oxley Highway															
10	L2	All MCs	450.0		450.0		0.062	6.1	LOSA	0.0	0.0	0.00	0.02	0.00	51.1
11	T1	All MCs	111	5.7	111	5.7	0.062	0.0	LOSA	0.0	0.0	0.00	0.02	0.00	59.9
Approach			115	7.3	115	7.3	0.062	0.2	NA	0.0	0.0	0.00	0.02	0.00	59.6
All Vehicles			343	5.8	343	5.8	0.099	2.1	NA	0.4	2.7	0.12	0.22	0.12	55.8

Site Level of Service (LOS) Method: Delay (RTA NSW). Site LOS Method is specified in the Parameter Settings dialog (Options tab).

Vehicle movement LOS values are based on average delay per movement.

Minor Road Approach LOS values are based on average delay for all vehicle movements.

NA (TWSC): Level of Service is not defined for major road approaches or the intersection as a whole for Two-Way Sign Control (HCM LOS rule).

Two-Way Sign Control Capacity Model: SIDRA Standard.

Delay Model: SIDRA Standard (Control Delay: Geometric Delay is included).

Queue Model: SIDRA queue estimation methods are used for Back of Queue and Queue at Start of Gap.

Gap-Acceptance Capacity Formula: SIDRA Standard (Akçelik M3D).

HV (%) values are calculated for All Movement Classes of All Heavy Vehicle Model Designation.

Arrival Flows used in performance calculations are adjusted to include any Initial Queued Demand and Upstream Capacity Constraint effects.

SIDRA INTERSECTION 9.1 | Copyright © 2000-2022 Akcelik and Associates Pty Ltd | sidrasolutions.com

Organisation: AMBER ORGANISATION | Licence: NETWORK / 1PC | Processed: Tuesday, 26 March 2024 4:15:40 PM

Project: C:\Users\olive\OneDrive - Amber Organisation Pty Ltd\Amber\Jobs\814 - Gilgandra Industrial Subdivision\Modelling\814 Gilgandra 240326.sip9

MOVEMENT SUMMARY

Site: 101 [Oxley Highway and Federation Street Intersection - Future AM (Site Folder: 20-year Future Scenario)]

Output produced by SIDRA INTERSECTION Version: 9.1.1.200

New Site
 Site Category: (None)
 Give-Way (Two-Way)

Vehicle Movement Performance															
Mov ID	Turn	Mov Class	Demand Flows		Arrival Flows		Deg. Satn	Aver. Delay	Level of Service	95% Back Of Queue		Prop. Que	Eff. Stop Rate	Aver. No. of Cycles	Aver. Speed
			[Total HV]	%	[Total HV]	%	v/c	sec		[Veh. veh	Dist] m				km/h
East: Oxley Highway															
5	T1	All MCs	180	6.4	180	6.4	0.146	0.0	LOSA	0.5	3.6	0.21	0.25	0.21	57.8
6	R2	All MCs	65	11.3	65	11.3	0.146	7.5	LOSA	0.5	3.6	0.21	0.25	0.21	50.7
Approach			245	7.7	245	7.7	0.146	2.0	NA	0.5	3.6	0.21	0.25	0.21	56.3
North: Federation Street															
7	L2	All MCs	87	4.8	87	4.8	0.070	5.3	LOSA	0.3	2.0	0.31	0.54	0.31	47.3
9	R2	All MCs	3	0.0	3	0.0	0.070	6.6	LOSA	0.3	2.0	0.31	0.54	0.31	47.2
Approach			91	4.7	91	4.7	0.070	5.4	LOSA	0.3	2.0	0.31	0.54	0.31	47.3
West: Oxley Highway															
10	L2	All MCs	100	0	100	0	0.114	6.7	LOSA	0.0	0.0	0.00	0.00	0.00	30.9
11	T1	All MCs	206	10.7	206	10.7	0.114	0.0	LOSA	0.0	0.0	0.00	0.00	0.00	59.9
Approach			207	11.2	207	11.2	0.114	0.1	NA	0.0	0.0	0.00	0.00	0.00	59.7
All Vehicles			543	8.5	543	8.5	0.146	1.8	NA	0.5	3.6	0.14	0.20	0.14	56.4

Site Level of Service (LOS) Method: Delay (RTA NSW). Site LOS Method is specified in the Parameter Settings dialog (Options tab).

Vehicle movement LOS values are based on average delay per movement.

Minor Road Approach LOS values are based on average delay for all vehicle movements.

NA (TWSC): Level of Service is not defined for major road approaches or the intersection as a whole for Two-Way Sign Control (HCM LOS rule).

Two-Way Sign Control Capacity Model: SIDRA Standard.

Delay Model: SIDRA Standard (Control Delay: Geometric Delay is included).

Queue Model: SIDRA queue estimation methods are used for Back of Queue and Queue at Start of Gap.

Gap-Acceptance Capacity Formula: SIDRA Standard (Akçelik M3D).

HV (%) values are calculated for All Movement Classes of All Heavy Vehicle Model Designation.

Arrival Flows used in performance calculations are adjusted to include any Initial Queued Demand and Upstream Capacity Constraint effects.

SIDRA INTERSECTION 9.1 | Copyright © 2000-2022 Akcelik and Associates Pty Ltd | sidrasolutions.com

Organisation: AMBER ORGANISATION | Licence: NETWORK / 1PC | Processed: Tuesday, 26 March 2024 4:16:31 PM

Project: C:\Users\olive\OneDrive - Amber Organisation Pty Ltd\Amber\Jobs\814 - Gilgandra Industrial Subdivision\Modelling\814 Gilgandra 240326.sip9

MOVEMENT SUMMARY

Site: 101 [Oxley Highway and Federation Street Intersection - Future PM (Site Folder: 20-year Future Scenario)]

Output produced by SIDRA INTERSECTION Version: 9.1.1.200

New Site
 Site Category: (None)
 Give-Way (Two-Way)

Vehicle Movement Performance															
Mov ID	Turn	Mov Class	Demand Flows		Arrival Flows		Deg. Satn	Aver. Delay	Level of Service	95% Back Of Queue		Prop. Que	Eff. Stop Rate	Aver. No. of Cycles	Aver. Speed
			[Total HV]	%	[Total HV]	%	v/c	sec		[Veh.]	[Dist]				km/h
			veh/h		veh/h					veh	m				
East: Oxley Highway															
5	T1	All MCs	145	5.8	145	5.8	0.136	0.0	LOSA	0.5	3.9	0.21	0.28	0.21	57.2
6	R2	All MCs	88	3.6	88	3.6	0.136	6.6	LOSA	0.5	3.9	0.21	0.28	0.21	50.7
Approach			234	5.0	234	5.0	0.136	2.5	NA	0.5	3.9	0.21	0.28	0.21	55.2
North: Federation Street															
7	L2	All MCs	72	4.4	72	4.4	0.055	5.1	LOSA	0.2	1.6	0.25	0.52	0.25	47.6
9	R2	All MCs	333.3		333.3		0.055	7.3	LOSA	0.2	1.6	0.25	0.52	0.25	45.7
Approach			75	5.6	75	5.6	0.055	5.2	LOSA	0.2	1.6	0.25	0.52	0.25	47.5
West: Oxley Highway															
10	L2	All MCs	650.0		650.0		0.082	6.1	LOSA	0.0	0.0	0.00	0.02	0.00	51.0
11	T1	All MCs	145	5.1	145	5.1	0.082	0.0	LOSA	0.0	0.0	0.00	0.02	0.00	59.8
Approach			152	6.9	152	6.9	0.082	0.3	NA	0.0	0.0	0.00	0.02	0.00	59.6
All Vehicles			460	5.7	460	5.7	0.136	2.2	NA	0.5	3.9	0.15	0.23	0.15	55.6

Site Level of Service (LOS) Method: Delay (RTA NSW). Site LOS Method is specified in the Parameter Settings dialog (Options tab).

Vehicle movement LOS values are based on average delay per movement.

Minor Road Approach LOS values are based on average delay for all vehicle movements.

NA (TWSC): Level of Service is not defined for major road approaches or the intersection as a whole for Two-Way Sign Control (HCM LOS rule).

Two-Way Sign Control Capacity Model: SIDRA Standard.

Delay Model: SIDRA Standard (Control Delay: Geometric Delay is included).

Queue Model: SIDRA queue estimation methods are used for Back of Queue and Queue at Start of Gap.

Gap-Acceptance Capacity Formula: SIDRA Standard (Akçelik M3D).

HV (%) values are calculated for All Movement Classes of All Heavy Vehicle Model Designation.

Arrival Flows used in performance calculations are adjusted to include any Initial Queued Demand and Upstream Capacity Constraint effects.

SIDRA INTERSECTION 9.1 | Copyright © 2000-2022 Akcelik and Associates Pty Ltd | sidrasolutions.com

Organisation: AMBER ORGANISATION | Licence: NETWORK / 1PC | Processed: Tuesday, 26 March 2024 4:18:33 PM

Project: C:\Users\olive\OneDrive - Amber Organisation Pty Ltd\Amber\Jobs\814 - Gilgandra Industrial Subdivision\Modelling\814 Gilgandra 240326.sip9

SITE LAYOUT

▽ Site: 101 [Oxley Highway and Hargraves Lane - Project AM
(Site Folder: Project Case)]

New Site
Site Category: (None)
Give-Way (Two-Way)

Layout pictures are schematic functional drawings reflecting input data. They are not design drawings.

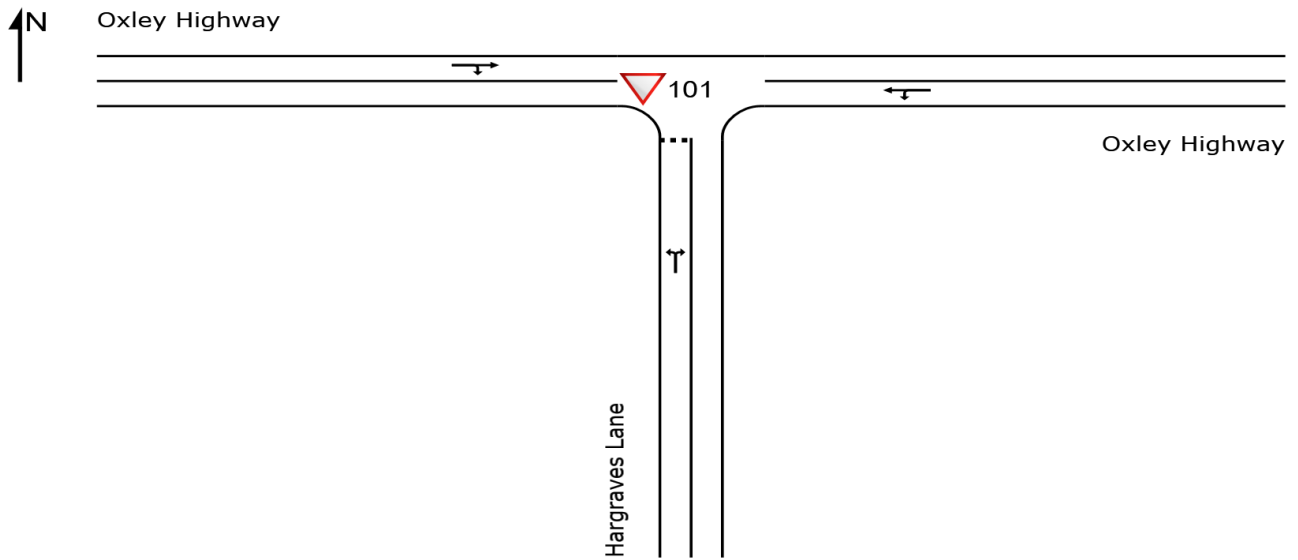

MOVEMENT SUMMARY

Site: 101 [Oxley Highway and Hargraves Lane - Project AM
(Site Folder: Project Case)]

Output produced by SIDRA INTERSECTION Version: 9.1.1.200

New Site
Site Category: (None)
Give-Way (Two-Way)

Vehicle Movement Performance															
Mov ID	Turn	Mov Class	Demand Flows		Arrival Flows		Deg. Satn	Aver. Delay	Level of Service	95% Back Of Queue		Prop. Que	Eff. Stop Rate	Aver. No. of Cycles	Aver. Speed
			[Total HV]	%	[Total HV]	%	v/c	sec		[Veh.]	[Dist]				km/h
			veh/h		veh/h					veh	m				
South: Hargraves Lane															
1	L2	All MCs	41	17.9	41	17.9	0.046	6.3	LOS A	0.2	1.4	0.28	0.56	0.28	51.3
3	R2	All MCs	9	44.4	9	44.4	0.046	8.5	LOS A	0.2	1.4	0.28	0.56	0.28	49.9
Approach			51	22.9	51	22.9	0.046	6.7	LOS A	0.2	1.4	0.28	0.56	0.28	51.1
East: Oxley Highway															
4	L2	All MCs	14	15.4	14	15.4	0.087	5.7	LOS A	0.0	0.0	0.00	0.05	0.00	56.3
5	T1	All MCs	147	5.7	147	5.7	0.087	0.0	LOS A	0.0	0.0	0.00	0.05	0.00	59.5
Approach			161	6.5	161	6.5	0.087	0.5	NA	0.0	0.0	0.00	0.05	0.00	59.3
West: Oxley Highway															
11	T1	All MCs	173	8.5	173	8.5	0.125	0.0	LOS A	0.3	2.4	0.14	0.17	0.14	58.3
12	R2	All MCs	45	7.0	45	7.0	0.125	6.9	LOS A	0.3	2.4	0.14	0.17	0.14	55.3
Approach			218	8.2	218	8.2	0.125	1.4	NA	0.3	2.4	0.14	0.17	0.14	57.7
All Vehicles			429	9.3	429	9.3	0.125	1.7	NA	0.3	2.4	0.10	0.17	0.10	57.4

Site Level of Service (LOS) Method: Delay (RTA NSW). Site LOS Method is specified in the Parameter Settings dialog (Options tab).

Vehicle movement LOS values are based on average delay per movement.

Minor Road Approach LOS values are based on average delay for all vehicle movements.

NA (TWSC): Level of Service is not defined for major road approaches or the intersection as a whole for Two-Way Sign Control (HCM LOS rule).

Two-Way Sign Control Capacity Model: SIDRA Standard.

Delay Model: SIDRA Standard (Control Delay: Geometric Delay is included).

Queue Model: SIDRA queue estimation methods are used for Back of Queue and Queue at Start of Gap.

Gap-Acceptance Capacity Formula: SIDRA Standard (Akçelik M3D).

HV (%) values are calculated for All Movement Classes of All Heavy Vehicle Model Designation.

Arrival Flows used in performance calculations are adjusted to include any Initial Queued Demand and Upstream Capacity Constraint effects.

SIDRA INTERSECTION 9.1 | Copyright © 2000-2022 Akcelik and Associates Pty Ltd | sidrasolutions.com

Organisation: AMBER ORGANISATION | Licence: NETWORK / 1PC | Processed: Tuesday, 26 March 2024 4:28:10 PM

Project: C:\Users\olive\OneDrive - Amber Organisation Pty Ltd\Amber\Jobs\814 - Gilgandra Industrial Subdivision\Modelling\814 Gilgandra 240326.sip9

MOVEMENT SUMMARY

Site: 101 [Oxley Highway and Hargraves Lane - Project PM
(Site Folder: Project Case)]

Output produced by SIDRA INTERSECTION Version: 9.1.1.200

New Site
Site Category: (None)
Give-Way (Two-Way)

Vehicle Movement Performance															
Mov ID	Turn	Mov Class	Demand Flows		Arrival Flows		Deg. Satn	Aver. Delay	Level of Service	95% Back Of Queue		Prop. Que	Eff. Stop Rate	Aver. No. of Cycles	Aver. Speed
			[Total HV]	%	[Total HV]	%	v/c	sec		[Veh.]	[Dist]				km/h
			veh/h		veh/h					veh	m				
South: Hargraves Lane															
1	L2	All MCs	60	1.8	60	1.8	0.050	5.9	LOS A	0.2	1.4	0.21	0.55	0.21	52.2
3	R2	All MCs	9	0.0	9	0.0	0.050	6.5	LOS A	0.2	1.4	0.21	0.55	0.21	52.0
Approach			69	1.5	69	1.5	0.050	6.0	LOS A	0.2	1.4	0.21	0.55	0.21	52.2
East: Oxley Highway															
4	L2	All MCs	7	28.6	7	28.6	0.060	5.9	LOS A	0.0	0.0	0.00	0.04	0.00	55.9
5	T1	All MCs	106	2.0	106	2.0	0.060	0.0	LOS A	0.0	0.0	0.00	0.04	0.00	59.7
Approach			114	3.7	114	3.7	0.060	0.4	NA	0.0	0.0	0.00	0.04	0.00	59.4
West: Oxley Highway															
11	T1	All MCs	131	2.4	131	2.4	0.093	0.0	LOS A	0.2	1.7	0.11	0.16	0.11	58.6
12	R2	All MCs	34	15.6	34	15.6	0.093	6.6	LOS A	0.2	1.7	0.11	0.16	0.11	55.1
Approach			164	5.1	164	5.1	0.093	1.4	NA	0.2	1.7	0.11	0.16	0.11	57.8
All Vehicles			347	3.9	347	3.9	0.093	2.0	NA	0.2	1.7	0.10	0.20	0.10	57.1

Site Level of Service (LOS) Method: Delay (RTA NSW). Site LOS Method is specified in the Parameter Settings dialog (Options tab).

Vehicle movement LOS values are based on average delay per movement.

Minor Road Approach LOS values are based on average delay for all vehicle movements.

NA (TWSC): Level of Service is not defined for major road approaches or the intersection as a whole for Two-Way Sign Control (HCM LOS rule).

Two-Way Sign Control Capacity Model: SIDRA Standard.

Delay Model: SIDRA Standard (Control Delay: Geometric Delay is included).

Queue Model: SIDRA queue estimation methods are used for Back of Queue and Queue at Start of Gap.

Gap-Acceptance Capacity Formula: SIDRA Standard (Akçelik M3D).

HV (%) values are calculated for All Movement Classes of All Heavy Vehicle Model Designation.

Arrival Flows used in performance calculations are adjusted to include any Initial Queued Demand and Upstream Capacity Constraint effects.

SIDRA INTERSECTION 9.1 | Copyright © 2000-2022 Akcelik and Associates Pty Ltd | sidrasolutions.com

Organisation: AMBER ORGANISATION | Licence: NETWORK / 1PC | Processed: Tuesday, 26 March 2024 4:29:06 PM

Project: C:\Users\olive\OneDrive - Amber Organisation Pty Ltd\Amber\Jobs\814 - Gilgandra Industrial Subdivision\Modelling\814 Gilgandra 240326.sip9

MOVEMENT SUMMARY

Site: 101 [Oxley Highway and Hargraves Lane - Future AM
(Site Folder: 20-year Future Scenario)]

Output produced by SIDRA INTERSECTION Version: 9.1.1.200

New Site
Site Category: (None)
Give-Way (Two-Way)

Vehicle Movement Performance															
Mov ID	Turn	Mov Class	Demand Flows		Arrival Flows		Deg. Satn	Aver. Delay	Level of Service	95% Back Of Queue		Prop. Que	Eff. Stop Rate	Aver. No. of Cycles	Aver. Speed
			[Total HV]	%	[Total HV]	%	v/c	sec		[Veh.]	[Dist]				km/h
			veh/h		veh/h					veh	m				
South: Hargraves Lane															
1	L2	All MCs	60	1.8	60	1.8	0.050	5.9	LOSA	0.2	1.4	0.21	0.55	0.21	52.2
3	R2	All MCs	9	0.0	9	0.0	0.050	6.5	LOSA	0.2	1.4	0.21	0.55	0.21	52.0
Approach			69	1.5	69	1.5	0.050	6.0	LOSA	0.2	1.4	0.21	0.55	0.21	52.2
East: Oxley Highway															
4	L2	All MCs	7	28.6	7	28.6	0.060	5.9	LOSA	0.0	0.0	0.00	0.04	0.00	55.9
5	T1	All MCs	106	2.0	106	2.0	0.060	0.0	LOSA	0.0	0.0	0.00	0.04	0.00	59.7
Approach			114	3.7	114	3.7	0.060	0.4	NA	0.0	0.0	0.00	0.04	0.00	59.4
West: Oxley Highway															
11	T1	All MCs	131	2.4	131	2.4	0.093	0.0	LOSA	0.2	1.7	0.11	0.16	0.11	58.6
12	R2	All MCs	34	15.6	34	15.6	0.093	6.6	LOSA	0.2	1.7	0.11	0.16	0.11	55.1
Approach			164	5.1	164	5.1	0.093	1.4	NA	0.2	1.7	0.11	0.16	0.11	57.8
All Vehicles			347	3.9	347	3.9	0.093	2.0	NA	0.2	1.7	0.10	0.20	0.10	57.1

Site Level of Service (LOS) Method: Delay (RTA NSW). Site LOS Method is specified in the Parameter Settings dialog (Options tab).

Vehicle movement LOS values are based on average delay per movement.

Minor Road Approach LOS values are based on average delay for all vehicle movements.

NA (TWSC): Level of Service is not defined for major road approaches or the intersection as a whole for Two-Way Sign Control (HCM LOS rule).

Two-Way Sign Control Capacity Model: SIDRA Standard.

Delay Model: SIDRA Standard (Control Delay: Geometric Delay is included).

Queue Model: SIDRA queue estimation methods are used for Back of Queue and Queue at Start of Gap.

Gap-Acceptance Capacity Formula: SIDRA Standard (Akçelik M3D).

HV (%) values are calculated for All Movement Classes of All Heavy Vehicle Model Designation.

Arrival Flows used in performance calculations are adjusted to include any Initial Queued Demand and Upstream Capacity Constraint effects.

SIDRA INTERSECTION 9.1 | Copyright © 2000-2022 Akcelik and Associates Pty Ltd | sidrasolutions.com

Organisation: AMBER ORGANISATION | Licence: NETWORK / 1PC | Processed: Tuesday, 26 March 2024 4:30:03 PM

Project: C:\Users\olive\OneDrive - Amber Organisation Pty Ltd\Amber\Jobs\814 - Gilgandra Industrial Subdivision\Modelling\814 Gilgandra 240326.sip9

MOVEMENT SUMMARY

Site: 101 [Oxley Highway and Hargraves Lane - Future PM
(Site Folder: 20-year Future Scenario)]

Output produced by SIDRA INTERSECTION Version: 9.1.1.200

New Site
Site Category: (None)
Give-Way (Two-Way)

Vehicle Movement Performance															
Mov ID	Turn	Mov Class	Demand Flows		Arrival Flows		Deg. Satn	Aver. Delay	Level of Service	95% Back Of Queue		Prop. Que	Eff. Stop Rate	Aver. No. of Cycles	Aver. Speed
			[Total HV]	%	[Total HV]	%	v/c	sec		[Veh.]	[Dist]				km/h
			veh/h		veh/h					veh	m				
South: Hargraves Lane															
1	L2	All MCs	80	2.6	80	2.6	0.070	6.0	LOSA	0.3	2.0	0.26	0.56	0.26	52.0
3	R2	All MCs	13	0.0	13	0.0	0.070	7.0	LOSA	0.3	2.0	0.26	0.56	0.26	51.9
Approach			93	2.3	93	2.3	0.070	6.2	LOSA	0.3	2.0	0.26	0.56	0.26	52.0
East: Oxley Highway															
4	L2	All MCs	11	30.0	11	30.0	0.082	5.9	LOSA	0.0	0.0	0.00	0.04	0.00	55.8
5	T1	All MCs	144	2.2	144	2.2	0.082	0.0	LOSA	0.0	0.0	0.00	0.04	0.00	59.7
Approach			155	4.1	155	4.1	0.082	0.4	NA	0.0	0.0	0.00	0.04	0.00	59.4
West: Oxley Highway															
11	T1	All MCs	175	2.4	175	2.4	0.124	0.0	LOSA	0.3	2.3	0.13	0.17	0.13	58.5
12	R2	All MCs	43	14.6	43	14.6	0.124	7.0	LOSA	0.3	2.3	0.13	0.17	0.13	55.1
Approach			218	4.8	218	4.8	0.124	1.4	NA	0.3	2.3	0.13	0.17	0.13	57.8
All Vehicles			465	4.1	465	4.1	0.124	2.0	NA	0.3	2.3	0.11	0.20	0.11	57.0

Site Level of Service (LOS) Method: Delay (RTA NSW). Site LOS Method is specified in the Parameter Settings dialog (Options tab).

Vehicle movement LOS values are based on average delay per movement.

Minor Road Approach LOS values are based on average delay for all vehicle movements.

NA (TWSC): Level of Service is not defined for major road approaches or the intersection as a whole for Two-Way Sign Control (HCM LOS rule).

Two-Way Sign Control Capacity Model: SIDRA Standard.

Delay Model: SIDRA Standard (Control Delay: Geometric Delay is included).

Queue Model: SIDRA queue estimation methods are used for Back of Queue and Queue at Start of Gap.

Gap-Acceptance Capacity Formula: SIDRA Standard (Akçelik M3D).

HV (%) values are calculated for All Movement Classes of All Heavy Vehicle Model Designation.

Arrival Flows used in performance calculations are adjusted to include any Initial Queued Demand and Upstream Capacity Constraint effects.

SIDRA INTERSECTION 9.1 | Copyright © 2000-2022 Akcelik and Associates Pty Ltd | sidrasolutions.com

Organisation: AMBER ORGANISATION | Licence: NETWORK / 1PC | Processed: Tuesday, 26 March 2024 4:30:46 PM

Project: C:\Users\olive\OneDrive - Amber Organisation Pty Ltd\Amber\Jobs\814 - Gilgandra Industrial Subdivision\Modelling\814 Gilgandra 240326.sip9

SITE LAYOUT

▽ Site: 101 [Castlereagh Highway and Federation Street - Project AM (Site Folder: Project Case)]

New Site
Site Category: (None)
Give-Way (Two-Way)

Layout pictures are schematic functional drawings reflecting input data. They are not design drawings.

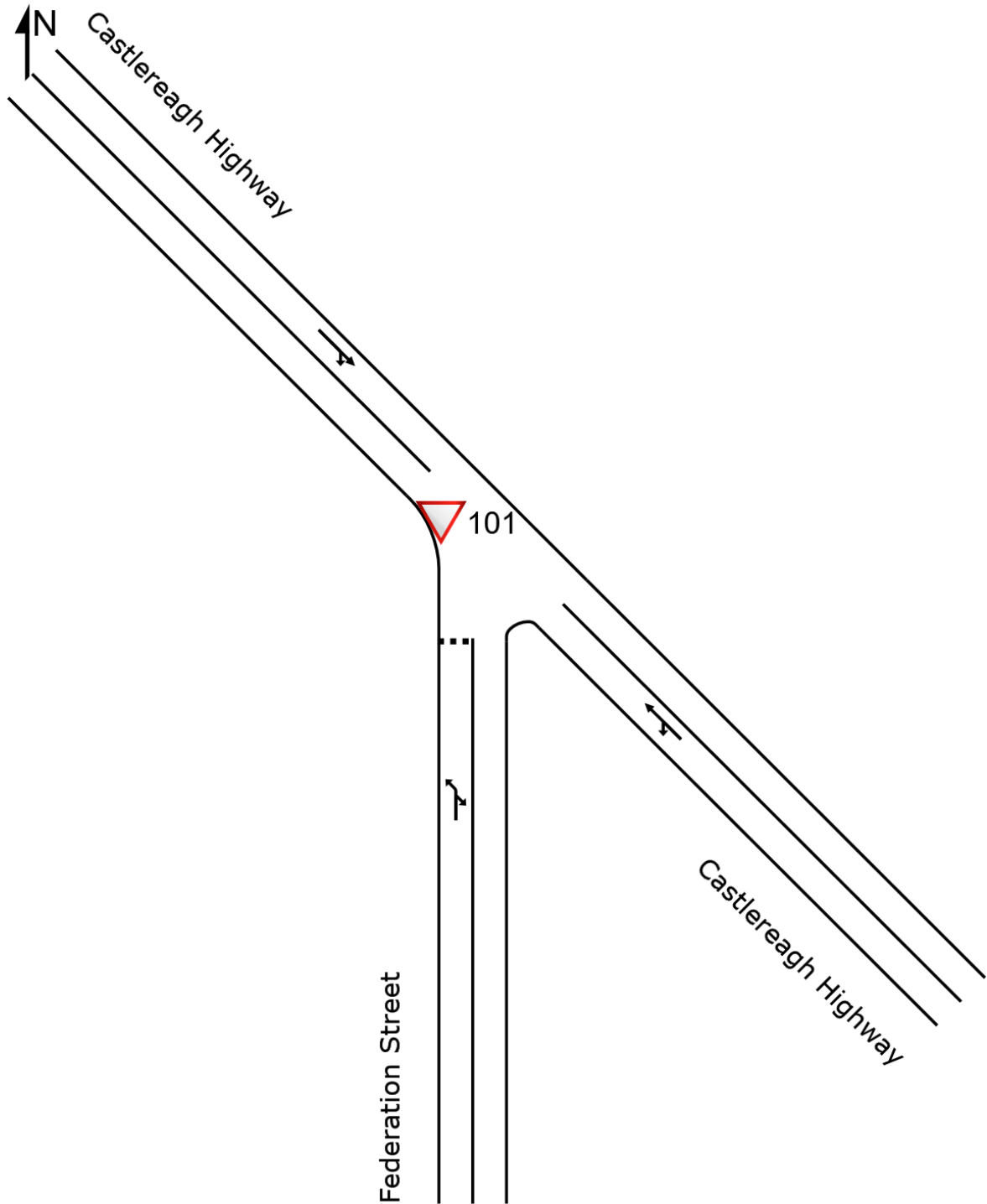

MOVEMENT SUMMARY

Site: 101 [Castlereagh Highway and Federation Street - Project AM (Site Folder: Project Case)]

Output produced by SIDRA INTERSECTION Version: 9.1.1.200

New Site
 Site Category: (None)
 Give-Way (Two-Way)

Vehicle Movement Performance															
Mov ID	Turn	Mov Class	Demand Flows		Arrival Flows		Deg. Satn	Aver. Delay	Level of Service	95% Back Of Queue		Prop. Que	Eff. Stop Rate	Aver. No. of Cycles	Aver. Speed
			[Total HV]	%	[Total HV]	%	v/c	sec		[Veh.]	[Dist]				km/h
			veh/h		veh/h					veh	m				
South: Federation Street															
1a	L1	All MCs	40	10.5	40	10.5	0.027	4.6	LOS A	0.1	0.8	0.09	0.52	0.09	48.4
3b	R3	All MCs	1	0.0	1	0.0	0.027	5.7	LOS A	0.1	0.8	0.09	0.52	0.09	48.7
Approach			41	10.3	41	10.3	0.027	4.6	LOS A	0.1	0.8	0.09	0.52	0.09	48.4
SouthEast: Castlereagh Highway															
21b	L3	All MCs	5	0.0	5	0.0	0.018	6.5	LOS A	0.0	0.0	0.00	0.55	0.00	53.7
22	T1	All MCs	27	3.8	27	3.8	0.018	4.2	LOS A	0.0	0.0	0.00	0.55	0.00	54.0
Approach			33	3.2	33	3.2	0.018	4.5	NA	0.0	0.0	0.00	0.55	0.00	53.9
NorthWest: Castlereagh Highway															
28	T1	All MCs	45	7.0	45	7.0	0.046	4.2	LOS A	0.0	0.0	0.00	0.54	0.00	54.0
29a	R1	All MCs	36	23.5	36	23.5	0.046	4.8	LOS A	0.0	0.0	0.00	0.54	0.00	53.1
Approach			81	14.3	81	14.3	0.046	4.5	NA	0.0	0.0	0.00	0.54	0.00	53.6
All Vehicles			155	10.9	155	10.9	0.046	4.5	NA	0.1	0.8	0.02	0.54	0.02	52.2

Site Level of Service (LOS) Method: Delay (RTA NSW). Site LOS Method is specified in the Parameter Settings dialog (Options tab).

Vehicle movement LOS values are based on average delay per movement.

Minor Road Approach LOS values are based on average delay for all vehicle movements.

NA (TWSC): Level of Service is not defined for major road approaches or the intersection as a whole for Two-Way Sign Control (HCM LOS rule).

Two-Way Sign Control Capacity Model: SIDRA Standard.

Delay Model: SIDRA Standard (Control Delay: Geometric Delay is included).

Queue Model: SIDRA queue estimation methods are used for Back of Queue and Queue at Start of Gap.

Gap-Acceptance Capacity Formula: SIDRA Standard (Akçelik M3D).

HV (%) values are calculated for All Movement Classes of All Heavy Vehicle Model Designation.

Arrival Flows used in performance calculations are adjusted to include any Initial Queued Demand and Upstream Capacity Constraint effects.

SIDRA INTERSECTION 9.1 | Copyright © 2000-2022 Akcelik and Associates Pty Ltd | sidrasolutions.com

Organisation: AMBER ORGANISATION | Licence: NETWORK / 1PC | Processed: Tuesday, 26 March 2024 4:32:02 PM

Project: C:\Users\olive\OneDrive - Amber Organisation Pty Ltd\Amber\Jobs\814 - Gilgandra Industrial Subdivision\Modelling\814 Gilgandra 240326.sip9

MOVEMENT SUMMARY

Site: 101 [Castlereagh Highway and Federation Street - Project PM (Site Folder: Project Case)]

Output produced by SIDRA INTERSECTION Version: 9.1.1.200

New Site
 Site Category: (None)
 Give-Way (Two-Way)

Vehicle Movement Performance															
Mov ID	Turn	Mov Class	Demand Flows		Arrival Flows		Deg. Satn	Aver. Delay	Level of Service	95% Back Of Queue		Prop. Que	Eff. Stop Rate	Aver. No. of Cycles	Aver. Speed
			[Total HV]	%	[Total HV]	%	v/c	sec		[Veh.]	[Dist]				km/h
			veh/h		veh/h					veh	m				
South: Federation Street															
1a	L1	All MCs	34	3.1	34	3.1	0.025	4.5	LOS A	0.1	0.7	0.08	0.53	0.08	48.7
3b	R3	All MCs	4	0.0	4	0.0	0.025	5.6	LOS A	0.1	0.7	0.08	0.53	0.08	48.6
Approach			38	2.8	38	2.8	0.025	4.6	LOS A	0.1	0.7	0.08	0.53	0.08	48.7
SouthEast: Castlereagh Highway															
21b	L3	All MCs	5	0.0	5	0.0	0.015	6.5	LOS A	0.0	0.0	0.00	0.55	0.00	53.6
22	T1	All MCs	23	0.0	23	0.0	0.015	4.1	LOS A	0.0	0.0	0.00	0.55	0.00	54.1
Approach			28	0.0	28	0.0	0.015	4.6	NA	0.0	0.0	0.00	0.55	0.00	54.0
NorthWest: Castlereagh Highway															
28	T1	All MCs	41	15.4	41	15.4	0.037	4.3	LOS A	0.0	0.0	0.00	0.54	0.00	53.7
29a	R1	All MCs	25	4.2	25	4.2	0.037	4.6	LOS A	0.0	0.0	0.00	0.54	0.00	53.9
Approach			66	11.1	66	11.1	0.037	4.4	NA	0.0	0.0	0.00	0.54	0.00	53.8
All Vehicles			133	6.3	133	6.3	0.037	4.5	NA	0.1	0.7	0.02	0.54	0.02	52.2

Site Level of Service (LOS) Method: Delay (RTA NSW). Site LOS Method is specified in the Parameter Settings dialog (Options tab).

Vehicle movement LOS values are based on average delay per movement.

Minor Road Approach LOS values are based on average delay for all vehicle movements.

NA (TWSC): Level of Service is not defined for major road approaches or the intersection as a whole for Two-Way Sign Control (HCM LOS rule).

Two-Way Sign Control Capacity Model: SIDRA Standard.

Delay Model: SIDRA Standard (Control Delay: Geometric Delay is included).

Queue Model: SIDRA queue estimation methods are used for Back of Queue and Queue at Start of Gap.

Gap-Acceptance Capacity Formula: SIDRA Standard (Akçelik M3D).

HV (%) values are calculated for All Movement Classes of All Heavy Vehicle Model Designation.

Arrival Flows used in performance calculations are adjusted to include any Initial Queued Demand and Upstream Capacity Constraint effects.

SIDRA INTERSECTION 9.1 | Copyright © 2000-2022 Akcelik and Associates Pty Ltd | sidrasolutions.com

Organisation: AMBER ORGANISATION | Licence: NETWORK / 1PC | Processed: Tuesday, 26 March 2024 4:32:42 PM

Project: C:\Users\olive\OneDrive - Amber Organisation Pty Ltd\Amber\Jobs\814 - Gilgandra Industrial Subdivision\Modelling\814 Gilgandra 240326.sip9

MOVEMENT SUMMARY

Site: 101 [Castlereagh Highway and Federation Street - Future AM (Site Folder: 20-year Future Scenario)]

Output produced by SIDRA INTERSECTION Version: 9.1.1.200

New Site
 Site Category: (None)
 Give-Way (Two-Way)

Vehicle Movement Performance															
Mov ID	Turn	Mov Class	Demand Flows		Arrival Flows		Deg. Satn	Aver. Delay	Level of Service	95% Back Of Queue		Prop. Que	Eff. Stop Rate	Aver. No. of Cycles	Aver. Speed
			[Total HV]	%	[Total HV]	%	v/c	sec		[Veh.]	[Dist]				km/h
			veh/h		veh/h					veh	m				
South: Federation Street															
1a	L1	All MCs	54	9.8	54	9.8	0.037	4.6	LOSA	0.1	1.1	0.11	0.52	0.11	48.4
3b	R3	All MCs	1	0.0	1	0.0	0.037	5.9	LOSA	0.1	1.1	0.11	0.52	0.11	48.6
Approach			55	9.6	55	9.6	0.037	4.7	LOSA	0.1	1.1	0.11	0.52	0.11	48.4
SouthEast: Castlereagh Highway															
21b	L3	All MCs	7	0.0	7	0.0	0.024	6.5	LOSA	0.0	0.0	0.00	0.55	0.00	53.7
22	T1	All MCs	37	2.9	37	2.9	0.024	4.2	LOSA	0.0	0.0	0.00	0.55	0.00	54.0
Approach			44	2.4	44	2.4	0.024	4.6	NA	0.0	0.0	0.00	0.55	0.00	53.9
NorthWest: Castlereagh Highway															
28	T1	All MCs	61	6.9	61	6.9	0.062	4.2	LOSA	0.0	0.0	0.00	0.54	0.00	54.0
29a	R1	All MCs	48	23.9	48	23.9	0.062	4.8	LOSA	0.0	0.0	0.00	0.54	0.00	53.1
Approach			109	14.4	109	14.4	0.062	4.5	NA	0.0	0.0	0.00	0.54	0.00	53.6
All Vehicles			208	10.6	208	10.6	0.062	4.5	NA	0.1	1.1	0.03	0.54	0.03	52.2

Site Level of Service (LOS) Method: Delay (RTA NSW). Site LOS Method is specified in the Parameter Settings dialog (Options tab).

Vehicle movement LOS values are based on average delay per movement.

Minor Road Approach LOS values are based on average delay for all vehicle movements.

NA (TWSC): Level of Service is not defined for major road approaches or the intersection as a whole for Two-Way Sign Control (HCM LOS rule).

Two-Way Sign Control Capacity Model: SIDRA Standard.

Delay Model: SIDRA Standard (Control Delay: Geometric Delay is included).

Queue Model: SIDRA queue estimation methods are used for Back of Queue and Queue at Start of Gap.

Gap-Acceptance Capacity Formula: SIDRA Standard (Akçelik M3D).

HV (%) values are calculated for All Movement Classes of All Heavy Vehicle Model Designation.

Arrival Flows used in performance calculations are adjusted to include any Initial Queued Demand and Upstream Capacity Constraint effects.

SIDRA INTERSECTION 9.1 | Copyright © 2000-2022 Akcelik and Associates Pty Ltd | sidrasolutions.com

Organisation: AMBER ORGANISATION | Licence: NETWORK / 1PC | Processed: Tuesday, 26 March 2024 4:33:18 PM

Project: C:\Users\olive\OneDrive - Amber Organisation Pty Ltd\Amber\Jobs\814 - Gilgandra Industrial Subdivision\Modelling\814 Gilgandra 240326.sip9

MOVEMENT SUMMARY

Site: 101 [Castlereagh Highway and Federation Street - Future PM (Site Folder: 20-year Future Scenario)]

Output produced by SIDRA INTERSECTION Version: 9.1.1.200

New Site
 Site Category: (None)
 Give-Way (Two-Way)

Vehicle Movement Performance															
Mov ID	Turn	Mov Class	Demand Flows		Arrival Flows		Deg. Satn	Aver. Delay	Level of Service	95% Back Of Queue		Prop. Que	Eff. Stop Rate	Aver. No. of Cycles	Aver. Speed
			[Total HV]	%	[Total HV]	%	v/c	sec		[Veh.]	[Dist]				km/h
			veh/h		veh/h					veh	m				
South: Federation Street															
1a	L1	All MCs	45	2.3	45	2.3	0.034	4.5	LOSA	0.1	0.9	0.10	0.52	0.10	48.7
3b	R3	All MCs	5	0.0	5	0.0	0.034	5.8	LOSA	0.1	0.9	0.10	0.52	0.10	48.6
Approach			51	2.1	51	2.1	0.034	4.7	LOSA	0.1	0.9	0.10	0.52	0.10	48.7
SouthEast: Castlereagh Highway															
21b	L3	All MCs	7	0.0	7	0.0	0.021	6.5	LOSA	0.0	0.0	0.00	0.55	0.00	53.6
22	T1	All MCs	32	0.0	32	0.0	0.021	4.1	LOSA	0.0	0.0	0.00	0.55	0.00	54.1
Approach			39	0.0	39	0.0	0.021	4.6	NA	0.0	0.0	0.00	0.55	0.00	54.0
NorthWest: Castlereagh Highway															
28	T1	All MCs	55	15.4	55	15.4	0.049	4.3	LOSA	0.0	0.0	0.00	0.54	0.00	53.7
29a	R1	All MCs	34	3.1	34	3.1	0.049	4.6	LOSA	0.0	0.0	0.00	0.54	0.00	53.9
Approach			88	10.7	88	10.7	0.049	4.4	NA	0.0	0.0	0.00	0.54	0.00	53.8
All Vehicles			178	5.9	178	5.9	0.049	4.5	NA	0.1	0.9	0.03	0.54	0.03	52.3

Site Level of Service (LOS) Method: Delay (RTA NSW). Site LOS Method is specified in the Parameter Settings dialog (Options tab).

Vehicle movement LOS values are based on average delay per movement.

Minor Road Approach LOS values are based on average delay for all vehicle movements.

NA (TWSC): Level of Service is not defined for major road approaches or the intersection as a whole for Two-Way Sign Control (HCM LOS rule).

Two-Way Sign Control Capacity Model: SIDRA Standard.

Delay Model: SIDRA Standard (Control Delay: Geometric Delay is included).

Queue Model: SIDRA queue estimation methods are used for Back of Queue and Queue at Start of Gap.

Gap-Acceptance Capacity Formula: SIDRA Standard (Akçelik M3D).

HV (%) values are calculated for All Movement Classes of All Heavy Vehicle Model Designation.

Arrival Flows used in performance calculations are adjusted to include any Initial Queued Demand and Upstream Capacity Constraint effects.

SIDRA INTERSECTION 9.1 | Copyright © 2000-2022 Akcelik and Associates Pty Ltd | sidrasolutions.com

Organisation: AMBER ORGANISATION | Licence: NETWORK / 1PC | Processed: Tuesday, 26 March 2024 4:33:47 PM

Project: C:\Users\olive\OneDrive - Amber Organisation Pty Ltd\Amber\Jobs\814 - Gilgandra Industrial Subdivision\Modelling\814 Gilgandra 240326.sip9

SITE LAYOUT

▽ Site: 101 [Newell Highway and Hargraves Lane - Project AM
(Site Folder: Project Case)]

New Site
Site Category: (None)
Give-Way (Two-Way)

Layout pictures are schematic functional drawings reflecting input data. They are not design drawings.

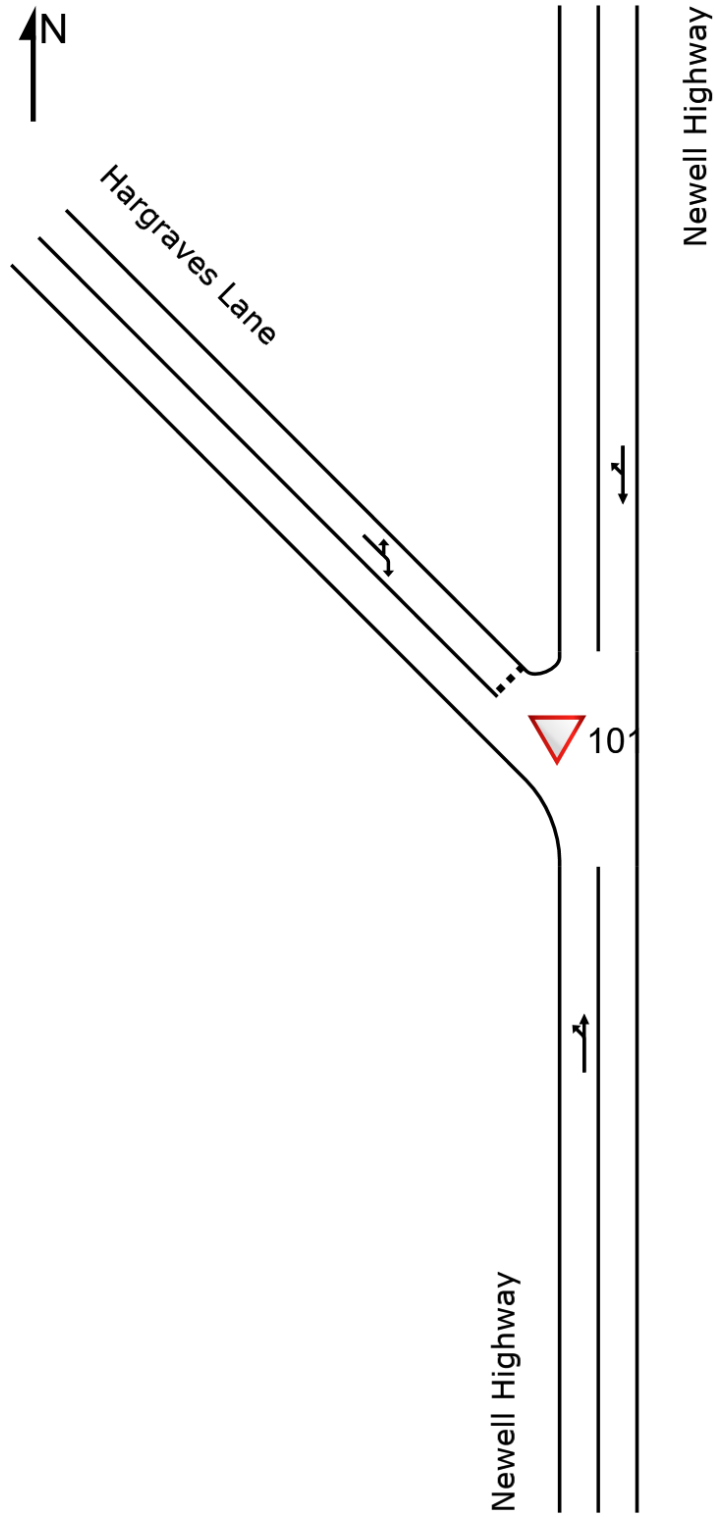

MOVEMENT SUMMARY

Site: 101 [Newell Highway and Hargraves Lane - Project AM
(Site Folder: Project Case)]

Output produced by SIDRA INTERSECTION Version: 9.1.1.200

New Site
Site Category: (None)
Give-Way (Two-Way)

Vehicle Movement Performance													
Mov ID	Turn	Mov Class	Demand Flows [Total HV] veh/h %	Arrival Flows [Total HV] veh/h %	Deg. Satn v/c	Aver. Delay sec	Level of Service	95% Back Of Queue [Veh. Dist] veh m	Prop. Que	Eff. Stop Rate	Aver. No. of Cycles	Aver. Speed km/h	
South: Newell Highway													
1a	L1	All MCs	35 18.2	35 18.2	0.087	5.6	LOS A	0.0	0.0	0.00	0.13	0.00	55.3
2	T1	All MCs	122 10.3	122 10.3	0.087	0.0	LOS A	0.0	0.0	0.00	0.13	0.00	58.9
Approach			157 12.1	157 12.1	0.087	1.2	NA	0.0	0.0	0.00	0.13	0.00	58.1
North: Newell Highway													
8	T1	All MCs	119 9.7	119 9.7	0.077	0.0	LOS A	0.1	0.8	0.07	0.10	0.07	59.2
9b	R3	All MCs	14 23.1	14 23.1	0.077	7.9	LOS A	0.1	0.8	0.07	0.10	0.07	55.0
Approach			133 11.1	133 11.1	0.077	0.8	NA	0.1	0.8	0.07	0.10	0.07	58.7
NorthWest: Hargraves Lane													
27b	L3	All MCs	8 0.0	8 0.0	0.059	6.9	LOS A	0.2	1.5	0.31	0.59	0.31	52.2
29a	R1	All MCs	49 10.6	49 10.6	0.059	6.3	LOS A	0.2	1.5	0.31	0.59	0.31	51.7
Approach			58 9.1	58 9.1	0.059	6.4	LOS A	0.2	1.5	0.31	0.59	0.31	51.8
All Vehicles			347 11.2	347 11.2	0.087	1.9	NA	0.2	1.5	0.08	0.20	0.08	57.1

Site Level of Service (LOS) Method: Delay (RTA NSW). Site LOS Method is specified in the Parameter Settings dialog (Options tab).

Vehicle movement LOS values are based on average delay per movement.

Minor Road Approach LOS values are based on average delay for all vehicle movements.

NA (TWSC): Level of Service is not defined for major road approaches or the intersection as a whole for Two-Way Sign Control (HCM LOS rule).

Two-Way Sign Control Capacity Model: SIDRA Standard.

Delay Model: SIDRA Standard (Control Delay: Geometric Delay is included).

Queue Model: SIDRA queue estimation methods are used for Back of Queue and Queue at Start of Gap.

Gap-Acceptance Capacity Formula: SIDRA Standard (Akçelik M3D).

HV (%) values are calculated for All Movement Classes of All Heavy Vehicle Model Designation.

Arrival Flows used in performance calculations are adjusted to include any Initial Queued Demand and Upstream Capacity Constraint effects.

SIDRA INTERSECTION 9.1 | Copyright © 2000-2022 Akcelik and Associates Pty Ltd | sidrasolutions.com

Organisation: AMBER ORGANISATION | Licence: NETWORK / 1PC | Processed: Tuesday, 26 March 2024 4:34:33 PM

Project: C:\Users\olive\OneDrive - Amber Organisation Pty Ltd\Amber\Jobs\814 - Gilgandra Industrial Subdivision\Modelling\814 Gilgandra 240326.sip9

MOVEMENT SUMMARY

Site: 101 [Newell Highway and Hargraves Lane - Project PM
(Site Folder: Project Case)]

Output produced by SIDRA INTERSECTION Version: 9.1.1.200

New Site
Site Category: (None)
Give-Way (Two-Way)

Vehicle Movement Performance															
Mov ID	Turn	Mov Class	Demand Flows		Arrival Flows		Deg. Satn	Aver. Delay	Level of Service	95% Back Of Queue		Prop. Que	Eff. Stop Rate	Aver. No. of Cycles	Aver. Speed
			[Total HV]	%	[Total HV]	%	v/c	sec		[Veh.]	[Dist]				km/h
			veh/h		veh/h					veh	m				
South: Newell Highway															
1a	L1	All MCs	39	18.9	39	18.9	0.086	5.6	LOS A	0.0	0.0	0.00	0.15	0.00	55.1
2	T1	All MCs	114	13.0	114	13.0	0.086	0.0	LOS A	0.0	0.0	0.00	0.15	0.00	58.7
Approach			153	14.5	153	14.5	0.086	1.4	NA	0.0	0.0	0.00	0.15	0.00	57.7
North: Newell Highway															
8	T1	All MCs	137	13.8	137	13.8	0.079	0.0	LOS A	0.0	0.2	0.02	0.02	0.02	59.7
9b	R3	All MCs	4	0.0	4	0.0	0.079	6.6	LOS A	0.0	0.2	0.02	0.02	0.02	56.7
Approach			141	13.4	141	13.4	0.079	0.2	NA	0.0	0.2	0.02	0.02	0.02	59.6
NorthWest: Hargraves Lane															
27b	L3	All MCs	5	20.0	5	20.0	0.055	7.1	LOS A	0.2	1.4	0.32	0.60	0.32	51.4
29a	R1	All MCs	45	16.3	45	16.3	0.055	6.5	LOS A	0.2	1.4	0.32	0.60	0.32	51.5
Approach			51	16.7	51	16.7	0.055	6.6	LOS A	0.2	1.4	0.32	0.60	0.32	51.5
All Vehicles			344	14.4	344	14.4	0.086	1.7	NA	0.2	1.4	0.06	0.17	0.06	57.5

Site Level of Service (LOS) Method: Delay (RTA NSW). Site LOS Method is specified in the Parameter Settings dialog (Options tab).

Vehicle movement LOS values are based on average delay per movement.

Minor Road Approach LOS values are based on average delay for all vehicle movements.

NA (TWSC): Level of Service is not defined for major road approaches or the intersection as a whole for Two-Way Sign Control (HCM LOS rule).

Two-Way Sign Control Capacity Model: SIDRA Standard.

Delay Model: SIDRA Standard (Control Delay: Geometric Delay is included).

Queue Model: SIDRA queue estimation methods are used for Back of Queue and Queue at Start of Gap.

Gap-Acceptance Capacity Formula: SIDRA Standard (Akçelik M3D).

HV (%) values are calculated for All Movement Classes of All Heavy Vehicle Model Designation.

Arrival Flows used in performance calculations are adjusted to include any Initial Queued Demand and Upstream Capacity Constraint effects.

SIDRA INTERSECTION 9.1 | Copyright © 2000-2022 Akcelik and Associates Pty Ltd | sidrasolutions.com

Organisation: AMBER ORGANISATION | Licence: NETWORK / 1PC | Processed: Tuesday, 26 March 2024 4:35:15 PM

Project: C:\Users\olive\OneDrive - Amber Organisation Pty Ltd\Amber\Jobs\814 - Gilgandra Industrial Subdivision\Modelling\814 Gilgandra 240326.sip9

MOVEMENT SUMMARY

Site: 101 [Newell Highway and Hargraves Lane - Future AM
(Site Folder: 20-year Future Scenario)]

Output produced by SIDRA INTERSECTION Version: 9.1.1.200

New Site
Site Category: (None)
Give-Way (Two-Way)

Vehicle Movement Performance															
Mov ID	Turn	Mov Class	Demand Flows		Arrival Flows		Deg. Satn	Aver. Delay	Level of Service	95% Back Of Queue		Prop. Que	Eff. Stop Rate	Aver. No. of Cycles	Aver. Speed
			[Total HV]	%	[Total HV]	%	v/c	sec		[Veh. veh	Dist] m				km/h
South: Newell Highway															
1a	L1	All MCs	45	20.9	45	20.9	0.117	5.6	LOS A	0.0	0.0	0.00	0.13	0.00	55.2
2	T1	All MCs	164	10.3	164	10.3	0.117	0.0	LOS A	0.0	0.0	0.00	0.13	0.00	58.9
Approach			209	12.6	209	12.6	0.117	1.2	NA	0.0	0.0	0.00	0.13	0.00	58.1
North: Newell Highway															
8	T1	All MCs	160	9.9	160	9.9	0.104	0.0	LOS A	0.2	1.2	0.09	0.11	0.09	59.1
9b	R3	All MCs	18	23.5	18	23.5	0.104	8.7	LOS A	0.2	1.2	0.09	0.11	0.09	55.0
Approach			178	11.2	178	11.2	0.104	0.9	NA	0.2	1.2	0.09	0.11	0.09	58.7
NorthWest: Hargraves Lane															
27b	L3	All MCs	12	0.0	12	0.0	0.088	7.0	LOS A	0.3	2.2	0.38	0.64	0.38	51.9
29a	R1	All MCs	66	11.1	66	11.1	0.088	6.9	LOS A	0.3	2.2	0.38	0.64	0.38	51.4
Approach			78	9.5	78	9.5	0.088	6.9	LOS A	0.3	2.2	0.38	0.64	0.38	51.5
All Vehicles			465	11.5	465	11.5	0.117	2.1	NA	0.3	2.2	0.10	0.21	0.10	57.1

Site Level of Service (LOS) Method: Delay (RTA NSW). Site LOS Method is specified in the Parameter Settings dialog (Options tab).

Vehicle movement LOS values are based on average delay per movement.

Minor Road Approach LOS values are based on average delay for all vehicle movements.

NA (TWSC): Level of Service is not defined for major road approaches or the intersection as a whole for Two-Way Sign Control (HCM LOS rule).

Two-Way Sign Control Capacity Model: SIDRA Standard.

Delay Model: SIDRA Standard (Control Delay: Geometric Delay is included).

Queue Model: SIDRA queue estimation methods are used for Back of Queue and Queue at Start of Gap.

Gap-Acceptance Capacity Formula: SIDRA Standard (Akçelik M3D).

HV (%) values are calculated for All Movement Classes of All Heavy Vehicle Model Designation.

Arrival Flows used in performance calculations are adjusted to include any Initial Queued Demand and Upstream Capacity Constraint effects.

SIDRA INTERSECTION 9.1 | Copyright © 2000-2022 Akcelik and Associates Pty Ltd | sidrasolutions.com

Organisation: AMBER ORGANISATION | Licence: NETWORK / 1PC | Processed: Tuesday, 26 March 2024 4:36:17 PM

Project: C:\Users\olive\OneDrive - Amber Organisation Pty Ltd\Amber\Jobs\814 - Gilgandra Industrial Subdivision\Modelling\814 Gilgandra 240326.sip9

MOVEMENT SUMMARY

Site: 101 [Newell Highway and Hargraves Lane - Future PM
(Site Folder: 20-year Future Scenario)]

Output produced by SIDRA INTERSECTION Version: 9.1.1.200

New Site
Site Category: (None)
Give-Way (Two-Way)

Vehicle Movement Performance													
Mov ID	Turn	Mov Class	Demand Flows [Total HV] veh/h %	Arrival Flows [Total HV] veh/h %	Deg. Satn v/c	Aver. Delay sec	Level of Service	95% Back Of Queue [Veh. Dist] veh m	Prop. Que	Eff. Stop Rate	Aver. No. of Cycles	Aver. Speed km/h	
South: Newell Highway													
1a	L1	All MCs	52 20.4	52 20.4	0.116	5.6	LOSA	0.0	0.0	0.00	0.15	0.00	55.1
2	T1	All MCs	154 13.0	154 13.0	0.116	0.0	LOSA	0.0	0.0	0.00	0.15	0.00	58.7
Approach			205 14.9	205 14.9	0.116	1.4	NA	0.0	0.0	0.00	0.15	0.00	57.8
North: Newell Highway													
8	T1	All MCs	184 13.7	184 13.7	0.107	0.0	LOSA	0.0	0.3	0.02	0.03	0.02	59.7
9b	R3	All MCs	5 0.0	5 0.0	0.107	7.1	LOSA	0.0	0.3	0.02	0.03	0.02	56.7
Approach			189 13.3	189 13.3	0.107	0.2	NA	0.0	0.3	0.02	0.03	0.02	59.6
NorthWest: Hargraves Lane													
27b	L3	All MCs	6 16.7	6 16.7	0.079	7.3	LOSA	0.3	2.1	0.39	0.65	0.39	51.1
29a	R1	All MCs	59 16.1	59 16.1	0.079	7.1	LOSA	0.3	2.1	0.39	0.65	0.39	51.1
Approach			65 16.1	65 16.1	0.079	7.2	LOSA	0.3	2.1	0.39	0.65	0.39	51.1
All Vehicles			460 14.4	460 14.4	0.116	1.7	NA	0.3	2.1	0.06	0.17	0.06	57.4

Site Level of Service (LOS) Method: Delay (RTA NSW). Site LOS Method is specified in the Parameter Settings dialog (Options tab).

Vehicle movement LOS values are based on average delay per movement.

Minor Road Approach LOS values are based on average delay for all vehicle movements.

NA (TWSC): Level of Service is not defined for major road approaches or the intersection as a whole for Two-Way Sign Control (HCM LOS rule).

Two-Way Sign Control Capacity Model: SIDRA Standard.

Delay Model: SIDRA Standard (Control Delay: Geometric Delay is included).

Queue Model: SIDRA queue estimation methods are used for Back of Queue and Queue at Start of Gap.

Gap-Acceptance Capacity Formula: SIDRA Standard (Akçelik M3D).

HV (%) values are calculated for All Movement Classes of All Heavy Vehicle Model Designation.

Arrival Flows used in performance calculations are adjusted to include any Initial Queued Demand and Upstream Capacity Constraint effects.

SIDRA INTERSECTION 9.1 | Copyright © 2000-2022 Akcelik and Associates Pty Ltd | sidrasolutions.com

Organisation: AMBER ORGANISATION | Licence: NETWORK / 1PC | Processed: Tuesday, 26 March 2024 4:36:41 PM

Project: C:\Users\olive\OneDrive - Amber Organisation Pty Ltd\Amber\Jobs\814 - Gilgandra Industrial Subdivision\Modelling\814 Gilgandra 240326.sip9

Appendix D

Site Access Intersection Design



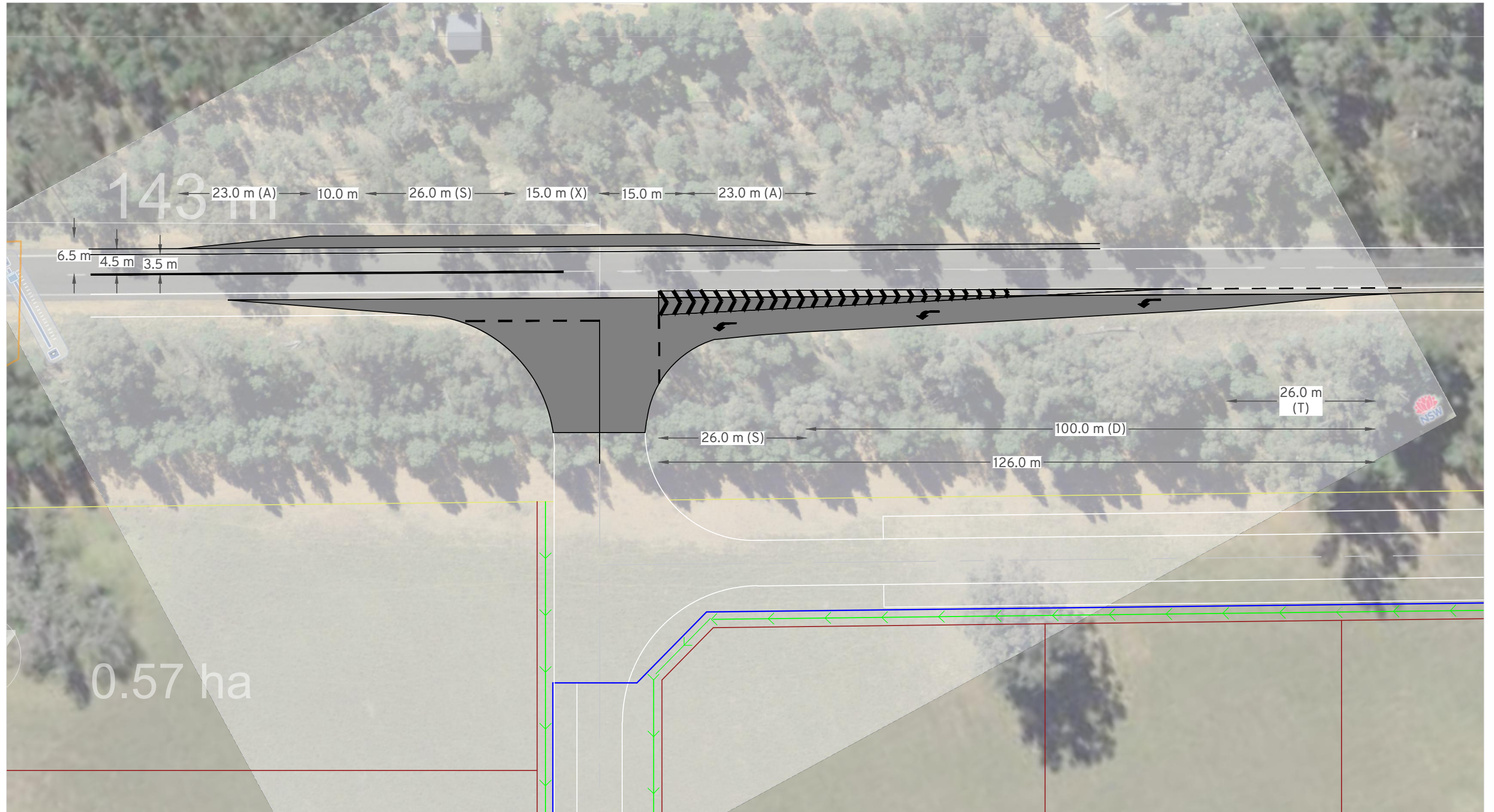

The following design details have been taken from Austroads Guide to Road Design Part 4A:

Basic Right-turn Treatment (BAR)

1. Design speed of 80km/h.
2. Design vehicle is a 26m B-Double.
3. Lane widths of 3.5m have been used.
4. Turn lane width is 3.5m.
5. Storage length is 26m for one B-Double Vehicle.

Offset Rural Channelised Left-Turn Treatment (CHL)

1. Design speed of 80km/h.
2. Design vehicle is a 26m B-Double.
3. Minimum Gap Sight Distance (MGSD) is 111m.
4. Lane widths of 3.5m have been used.
5. Taper length calculates to 26m, adjusted to provide MGSD.



Industrial Development
 361 Oxley Highway, Gilgandra
 Strategic Design - Access

DRAWN: TD
 DATE: 21/02/2024
 DWG NO: 814 D01A
 SCALE at A3: 1:750m



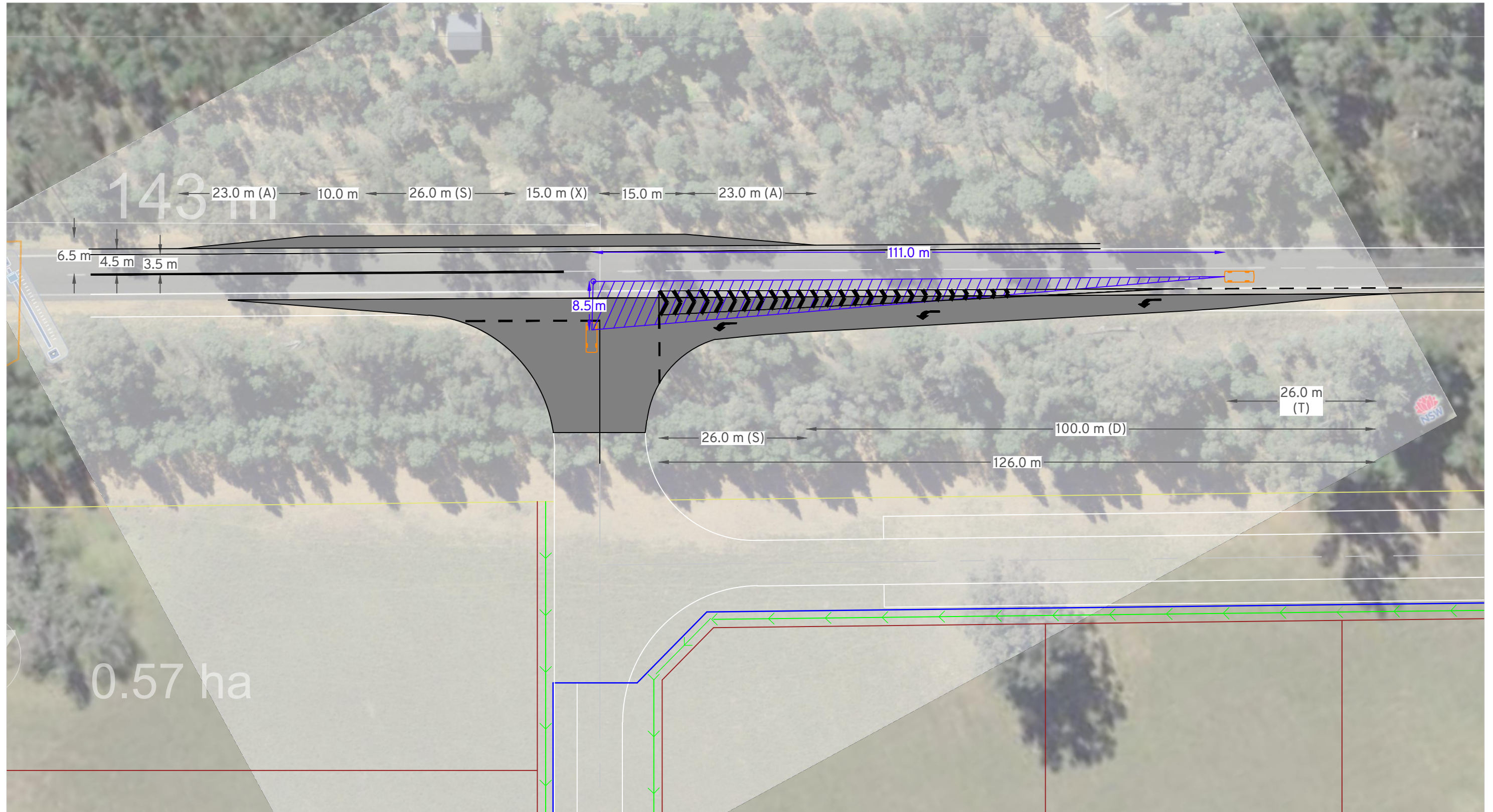

The following design details have been taken from Austroads Guide to Road Design Part 4A:

Basic Right-turn Treatment (BAR)

1. Design speed of 80km/h.
2. Design vehicle is a 26m B-Double.
3. Lane widths of 3.5m have been used.
4. Turn lane width is 3.5m.
5. Storage length is 26m for one B-Double Vehicle.

Offset Rural Channelised Left-Turn Treatment (CHL)

1. Design speed of 80km/h.
2. Design vehicle is a 26m B-Double.
3. Minimum Gap Sight Distance (MGSD) is 111m.
4. Lane widths of 3.5m have been used.
5. Taper length calculates to 26m, adjusted to provide MGSD.



Industrial Development

361 Oxley Highway, Gilgandra

Strategic Design - Access - MGSD for Rural CHL

DRAWN: TD
 DATE: 21/02/2024
 DWG NO: 814 D01A
 SCALE at A3: 1:750m



Appendix E

Swept Path Assessment – Site Access



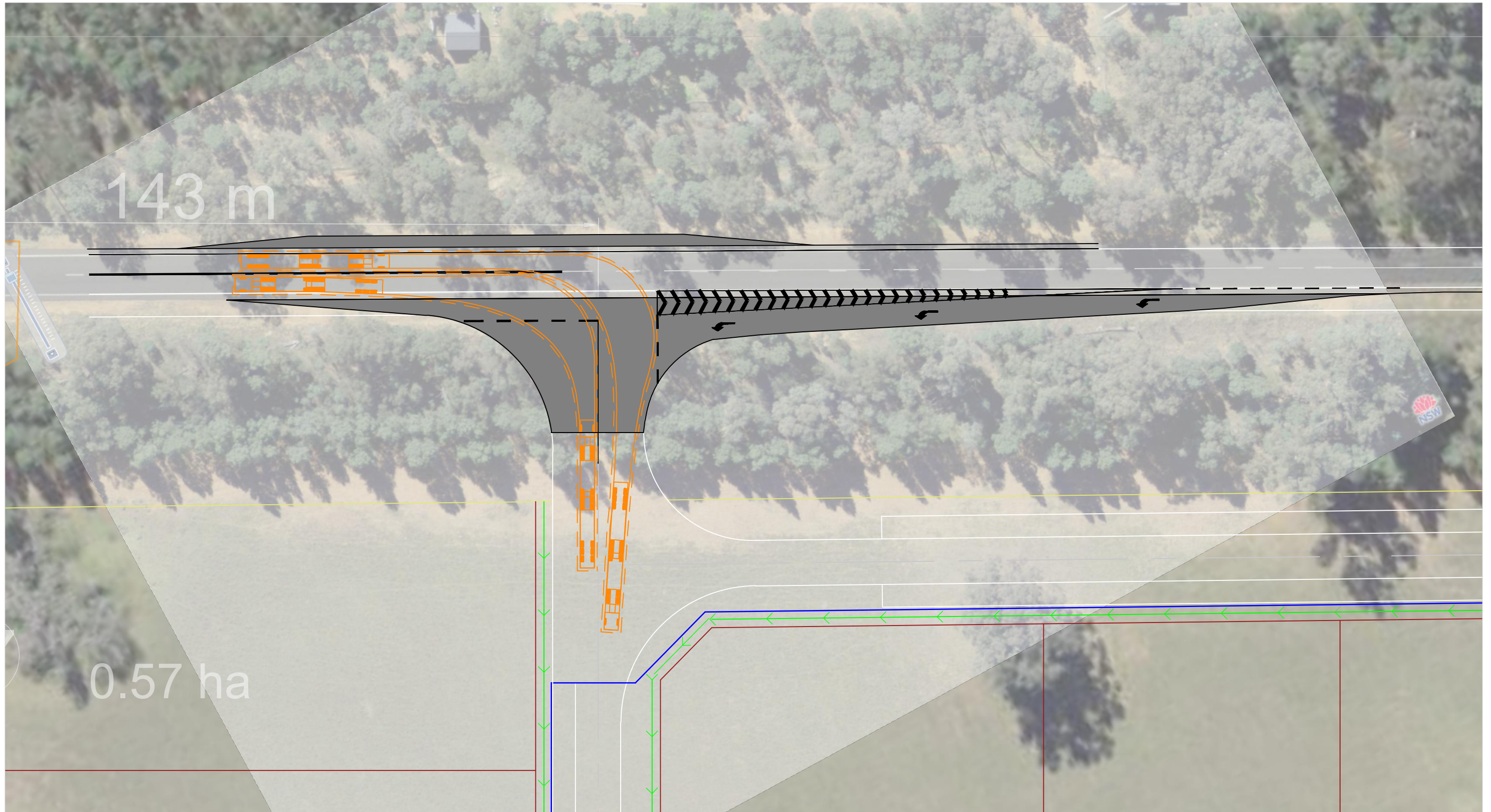

Vehicle Envelope
 500mm Clearance
 Reverse Manoeuvre
 Min. Design Speed 5km/h

26.0m B-Double

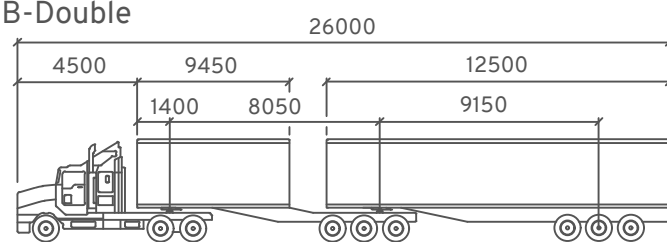

Tractor Width : 2500 mm
 Trailer Width : 2500
 Tractor Track : 2500
 Trailer Track : 2500
 Lock to Lock : 6.0s
 Steering Angle : 22.2
 Articulating Angle 70.0



Industrial Development
 361 Oxley Highway, Gilgandra
 Strategic Design - Access - Swept Path Assessment

DRAWN: TD
 DATE: 21/02/2024
 DWG NO: 814 D01A
 SCALE at A3: 1:750m



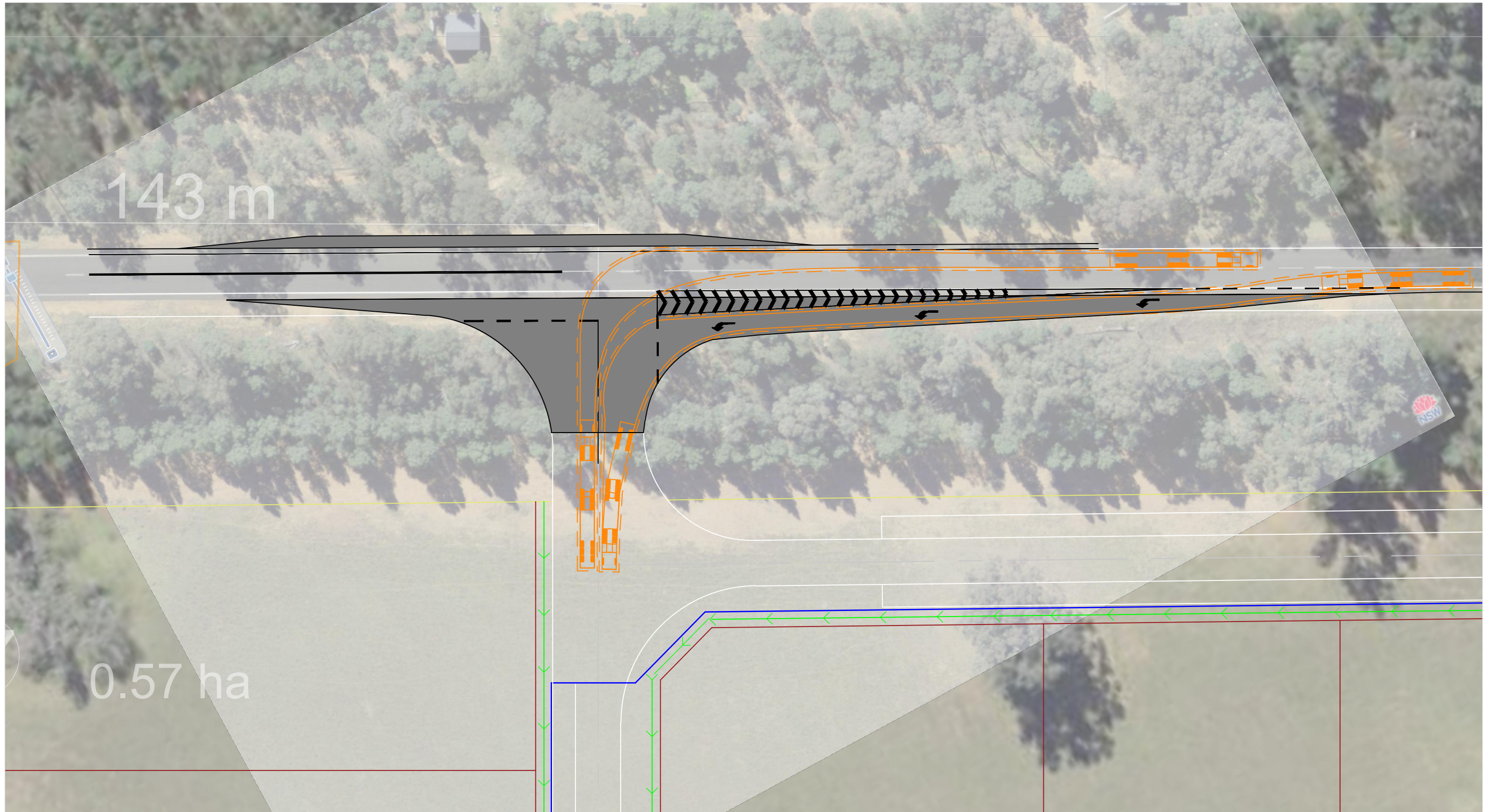

Vehicle Envelope
 500mm Clearance
 Reverse Manoeuvre
 Min. Design Speed 5km/h

26.0m B-Double

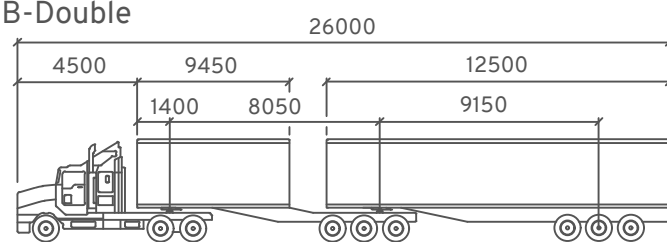

Tractor Width : 2500 mm
 Trailer Width : 2500
 Tractor Track : 2500
 Trailer Track : 2500
 Lock to Lock : 6.0s
 Steering Angle : 22.2
 Articulating Angle 70.0



Industrial Development
 361 Oxley Highway, Gilgandra
 Strategic Design - Access - Swept Path Assessment

DRAWN: TD
 DATE: 21/02/2024
 DWG NO: 814 D01A
 SCALE at A3: 1:750m



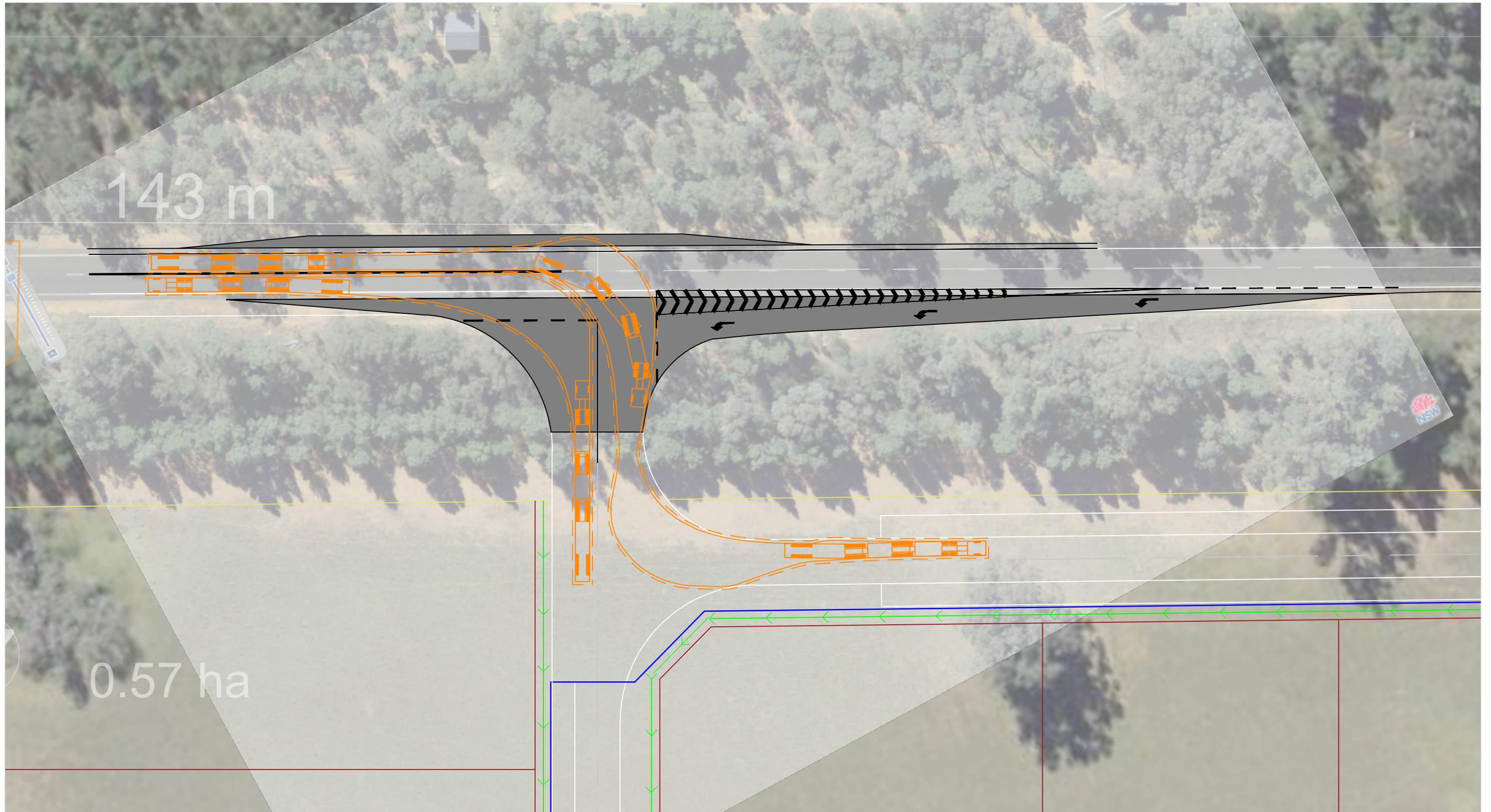

Vehicle Envelope
 500mm Clearance
 Reverse Manoeuvre
 Min. Design Speed 5km/h

35.4m B-Triple

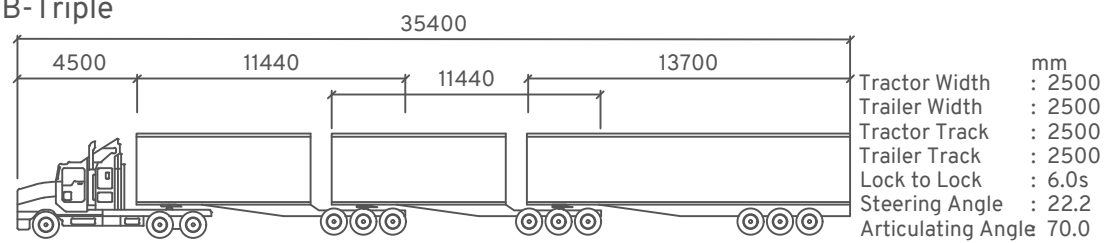

Industrial Development
 361 Oxley Highway, Gilgandra
 Strategic Design - Access - Swept Path Assessment

DRAWN: TD
 DATE: 21/02/2024
 DWG NO: 814 D01A
 SCALE at A3: 1:750m



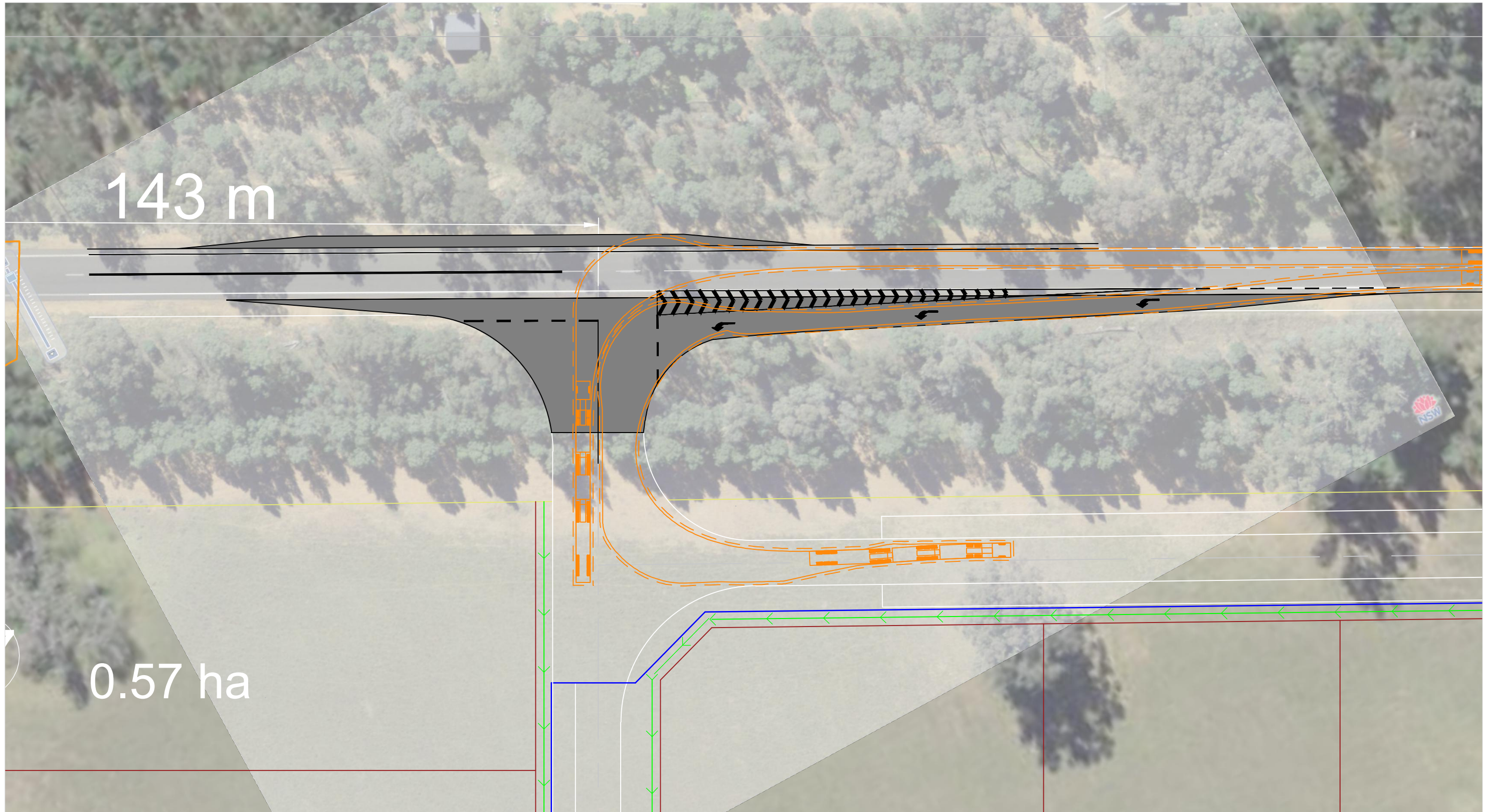

Vehicle Envelope
 500mm Clearance
 Reverse Manoeuvre
 Min. Design Speed 5km/h

35.4m B-Triple

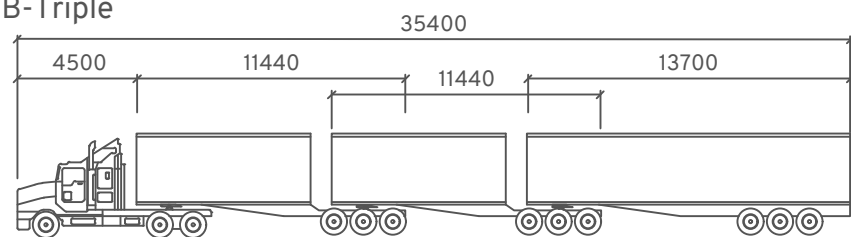

Tractor Width : 2500 mm
 Trailer Width : 2500
 Tractor Track : 2500
 Trailer Track : 2500
 Lock to Lock : 6.0s
 Steering Angle : 22.2
 Articulating Angle 70.0



Industrial Development
 361 Oxley Highway, Gilgandra
 Strategic Design - Access - Swept Path Assessment

DRAWN: TD
 DATE: 21/02/2024
 DWG NO: 814 D01A
 SCALE at A3: 1:750m



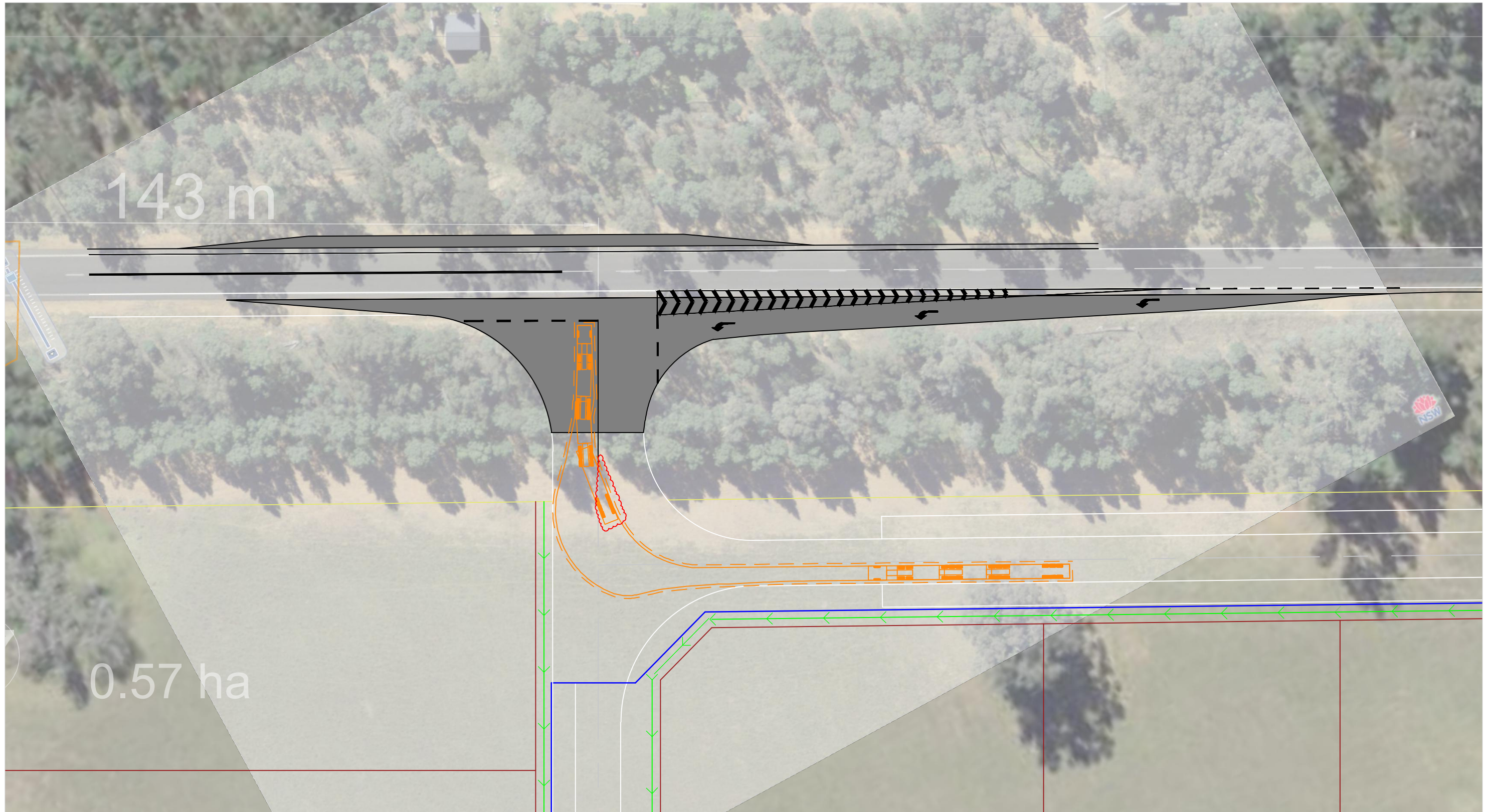

Vehicle Envelope
 500mm Clearance
 Reverse Manoeuvre
 Min. Design Speed 5km/h

35.4m B-Triple

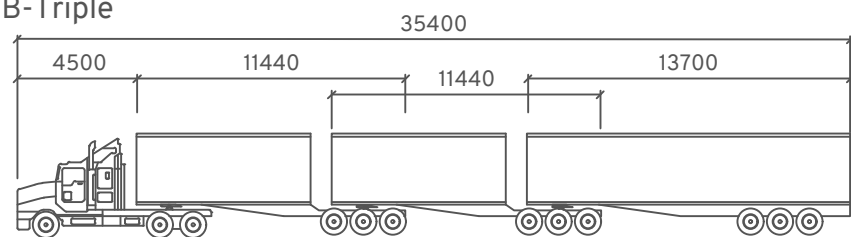

Tractor Width : 2500 mm
 Trailer Width : 2500 mm
 Tractor Track : 2500 mm
 Trailer Track : 2500 mm
 Lock to Lock : 6.0s
 Steering Angle : 22.2
 Articulating Angle 70.0



Industrial Development
 361 Oxley Highway, Gilgandra
 Strategic Design - Access - Swept Path Assessment

DRAWN: TD
 DATE: 21/02/2024
 DWG NO: 814 D01A
 SCALE at A3: 1:750m

